



LT1320

Belt Weigher Indicator

Operating Manual – English 1.00



7 Segment
LED Display



128x64
Pixels
Graphic LCD
Display

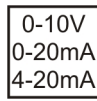

0-10V
0-20mA
4-20mA
Analog
Re-Transmission



5VDC
Excitation



High Resolution
ADC



High Resolution
DAC



RTU
ASCII
Modbus™
Communications

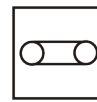

Dynamic
Calibration



Field upgradeable
Firmware



Dynamic
Tare



Advanced
Digital Filtering



Real Time
Clock

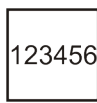

Resettable Totaliser
Non-Resettable Totaliser

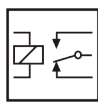

4 Alarm
Setpoints

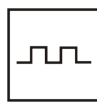

Encoder /
Tacho-Generator
Input



RS232
&
RS485

Introduction

The LT1320 Belt Weigher indicator is a precision digital indicator for belt weighing applications. The LT1320 takes the weight and speed information from a belt conveyor system to accurately calculate rate and total material transferred.

The high bright 6-digit 7-segment 20mm LED displays and the sunlight readable graphic LCD display make for easy setup and readability. A simple menu system allows for easy configuration of display and belt weighing settings.

The load cell calibration can be done directly from the load cell calibration certificate or by using dynamic calibration of the belt conveyor system. The LT1320 also provides an internal jumper selectable power supply for powering an encoder / tachogenerator and a pulse counting digital input to measure the speed of the belt conveyor system.

A universal mains switch mode power supply (85-264VAC) is provided as standard but an optional low voltage (10-30VDC) isolated power supply can be installed.

The LT1320 contains precision front end circuitry for high accuracy and stability. The ratiometric ADC circuitry automatically compensates for temperature drift and excitation voltage variances due to cable loss. The load cell excitation voltage is 5VDC and can interface with both 4 wire and 6 wire load cells. The LT1320 can power up to 6x350Ω load cells.

RS232 and RS485 communications is supplied as standard with the MODBUS™ RTU and MODBUS™ ASCII protocol. A simple ASCII out protocol is also provided for serial printing and communicating to large displays.

The LT1320 also has analog out circuitry to generate a precision 0/4-20mA or 0-10V analog output signal.

The LT1320 also includes advanced features such as a resettable and non-resettable totaliser, dynamic tare function, auto-zero tracking, user input linearisation, max recording, programmable front push buttons, programmable digital inputs, security menu lockout, dead band adjustment, advanced digital filtering, dynamic calibration, pulse output plus many more to provide a all in one precision belt weighing indicator.

1 Features

- 4 or 6 wire load cell / strain gauge input
- Can power up to 6x350Ω load cells at +5Vdc excitation voltage
- Dynamic tare function
- Dynamic calibration function
- Dead band adjustment to determine the minimum rate at which the LT1320 will cease to totalise
- A resettable and non-resettable totaliser
- Encoder / Tacho-generator pulse counting Input with jumper selectable power supply
- High precision 24bit ADC front end circuitry
- -199999 to +999999 display counts
- High bright 6-digit 7-segment 20mm LED displays
- 128x64 pixel backlit sunlight readable graphic LCD display for easy setup and calibration
- Easy calibration either from the load cell calibration certificate or by using known weights
- RS232 and RS485 communications (MODBUS™ RTU/ASCII and a serial ASCII out protocol)
- 180x180x60mm flame retardant ABS enclosure
- Universal mains switch mode power supply (85-264VAC) standard with built in EMI and fuse protection
- 4x Mechanical (FORM-C) relays
- 3x Programmable digital inputs
- 16 Point lineariser
- Auto-zero tracking
- High precision 16bit Analog output (0/4-20mA, 0-10V)
- Selectable/adjustable advanced digital filtering
- 8 front panel LED indicators for alarm set point status, rate display, total display, dead range and print
- Pulse output function
- Full alpha-numeric keypad
- Front programmable function keys (Rate, Total, Print, Dynamic tare and Alarm latch reset)
- Max value recording (weight, speed & rate)
- RTC (Real Time Clock) for time and date stamping
- Cage clamp wire connectors for easy installation
- Field upgradable firmware via the RS232 interface
- 1 Year Warranty

Additional hardware options include:

- Up to 4 solid state (FORM-A) relays
- Low voltage 10-30VDC Isolated power supply
- 16 Bit Isolated analog output (0/4-20mA, 0-10V)



This instrument is marked with the international hazard symbol. It is important to read this manual before installing or commissioning your wall mount indicator as it contains important information relating to safety and Electromagnetic Compatibility EMC.

ENSURE THAT ALL POWER IS SWITCHED OFF TO THE INSTRUMENT BEFORE INSTALLING OR DOING MAINTENANCE WORK.

- **Do not place signal and power supply wiring in the same loom.**
- **Make sure that all anti-static precautions are adhered to when handling the circuit boards.**
- **Use screened cable for all signal inputs and attach to earth at one point only.**
- **Use ferrules with all input connections for greater reliability.**



The instrument contains a battery for data retention purposes. The battery should be disposed of correctly. Please contact your supplier or local council if in doubt.

2 Specifications

General:	
LED Display	6-Digit, 20mm (0.8") 7 segment high brightness red LED
LCD Display	128x64 Full graphic sunlight readable monochrome display
LCD Backlight	Yellow/Green, User defined on/off control
Display range	-199999 to +999999
Display decimal point	0 to 0.00000
Status LEDs	8 LEDs total (SP1, SP2, SP3, SP4, Rate, Total, Dead Range & Print)
Digital Inputs	3 Programmable digital inputs Built in hysteresis, filter and input over voltage protection Maximum input voltage <30VDC (Pull up, sinking inputs) - 10k Ω internal resistor to +5V Active/Non-Active input trigger: <1.9V Non-Active/Active input trigger: >2.3V
Keypad	Full 4x3 alpha-numeric keyboard 4 Dedicated function keys (Rate, Total, Print, Tare) 1 Dual function key (Alarm latch reset)
Memory storage	Non-volatile EEPROM, 100000 write cycles minimum
Warm up time	15 minutes
Power Requirements:	
AC Power Supply	85-264VAC, 50/60Hz or 120-370VDC Isolation: 3000VAC/1min
DC Power Supply, 10-30VDC (Optional)	10-30VDC input Reverse and over voltage protected Isolation: >1000V/1min
Power Consumption	<10W
Fuse (Built in)	2A Slow Blow (Wickmann 3721200000) RS components part number 226-6599
Environmental:	
Operating temperature	-10°C to 50°C (14°F to 122°F)
Storage temperature	-40°C to 80°C (-40°F to 176°F)
Operating and storage humidity	<85% RH non-condensing
Enclosure:	
Overall Dimensions	180x180x60mm (LxHxD) (7.09x7.09x2.36") (Height includes cable glands)
Mounting Holes	159x94mm (6.26x3.7")
Enclosure Material	ABS – Flame Retardant (UL 94 V-0)
IP Rating	IP65 / NEMA 4 / UL Type 4
Gland Ratings:	
Clamping/sealing range (Small gland)	4-8mm (0.157-0.314") Diameter wire
Clamping/sealing range (Large gland)	7-13mm (0.276"-0.512") Diameter wire
Input:	
ADC Resolution	24 bit Delta-sigma, Ratiometric
Input range	+/-3.5mV/V
Conversion rate	10 updates/second
Filter	Moving average digital filter with programmable input step detection
Increment size	1, 2, 5, 10, 20, 50, 100, 200
Input Impedance	>100M Ω
CMRR	>-110dB
Linearity	<0.01% of full scale

Accuracy	0.05% of full scale
Calibration method	From the load cell calibration certificate or from using known weights
Load cell connection	4 or 6 wire connection + shield (Sense included)
Load Cell Excitation:	
Excitation Voltage (Sense included)	+5Vdc Fixed
Excitation current	Max. 90mA Up to 6x350Ω load cells or 10x1000Ω load cells
Cable compensation	Ratiometric
Encoder / Tacho-generator Input:	
Range	20KHz
Measurement type	<500Hz Period measurement >500Hz Pulse measurement
Excitation	Jumper selectable +5Vdc, +12Vdc, 24Vdc
Maximum excitation current	100mA
Analog Out:	
Ranges (Selectable through menu)	0-20mA 4-20mA 0-10V
DAC Resolution	16 Bit
Update rate	12 updates/second
Current output compliance (max load)	500Ω (Current is source, not sink)
Voltage output compliance (min load)	1kΩ
Current open loop detection	LCD display flashes "Loop Error" error message
Linearity	<0.02% of full scale
Accuracy	0.05% of full scale
Isolation (Optional)	1000VDC @ 1mA for 1 minute
Communications:	
Protocol	MODBUS RTU MODBUS ASCII ASCII In (Infiniteq Protocol) ASCII Out (Infiniteq Protocol)
RS232 Communications	Baud rate: 1200,2400,4800,9600,19200,38400,57600,115200 Data bits: 7 or 8 bits Parity: Odd, Even or None Stop bits: 1 or 2 stop bits Non isolated
RS485 Communications	Baud rate: 1200,2400,4800,9600,19200,38400,57600,115200 Data bits: 7 or 8 bits Parity: Odd, Even or None Stop bits: 1 or 2 stop bits Internal 120Ω field jumper selectable termination resistor Max 32 instruments per line
SetPoints:	
Electro-mechanical Relays:	
Contact rating	2A@240VAC or 30VDC (Resistive load)
Isolation to input circuitry	>1000Vrms for 1 minute
Type	FORM-C (Change over contact (NO/NC))
Life expectancy	>100K cycles min. at full load rating. External RC snubber extends relay life for operation with inductive loads
Solid-State Relays (SSR): (Optional, Up to 4 can be fitted)	
Contact rating	120mA@400VAC/DC
Isolation to input circuitry	>1000Vrms for 1 minute
Type	FORM-A (Normally open)

RTC (Real Time Clock):	
Battery	CR2032
Accuracy	Better then 2 seconds per day (Temperature dependent)

3 Installation

3.1 Enclosure Dimensions

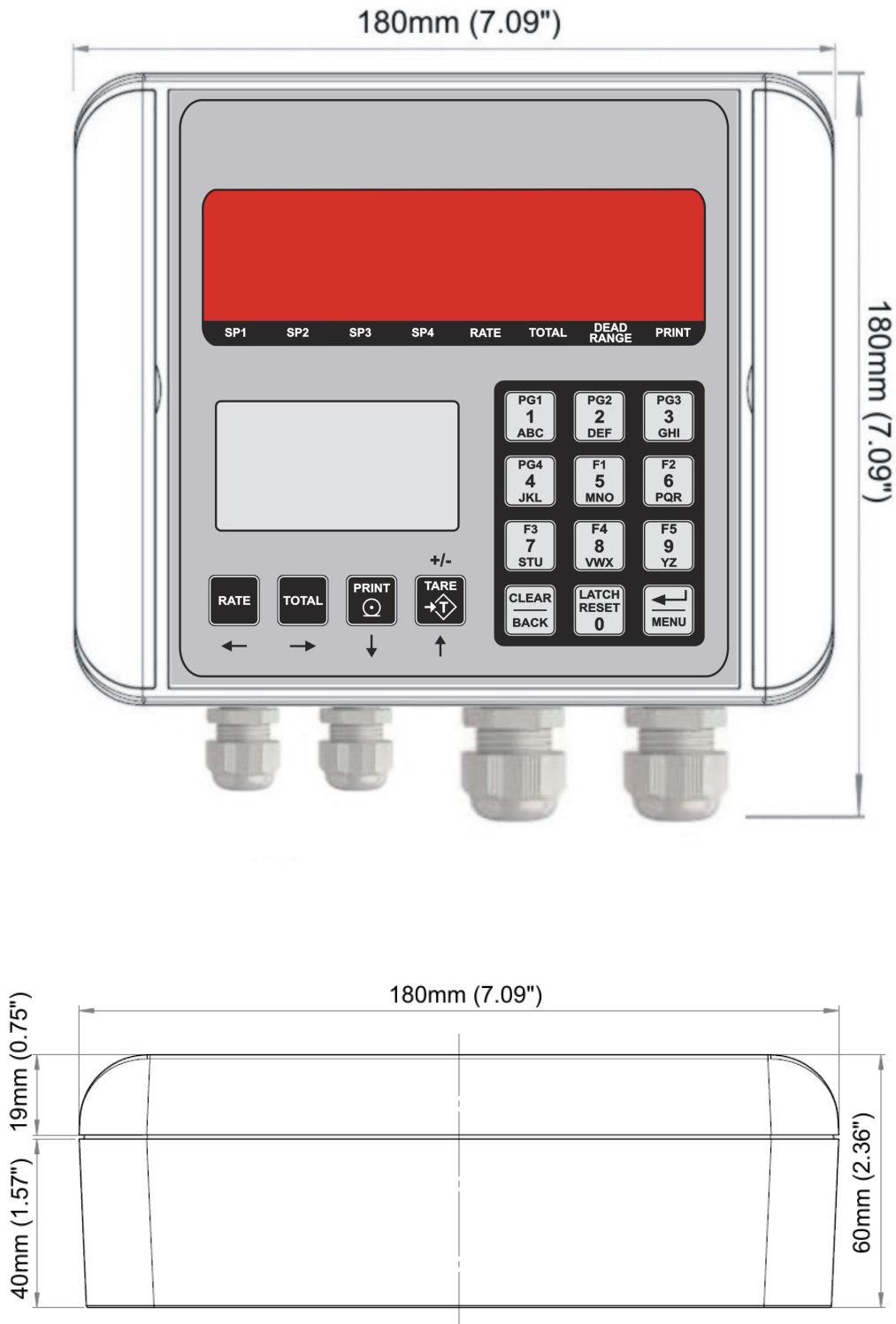

3.2 Mounting Template

The below diagram shows the location of the enclosure mounting holes. The mounting hole dimensions are also available on the underside of the enclosure. The 2 side cover strips must be opened to gain access to the mounting holes.

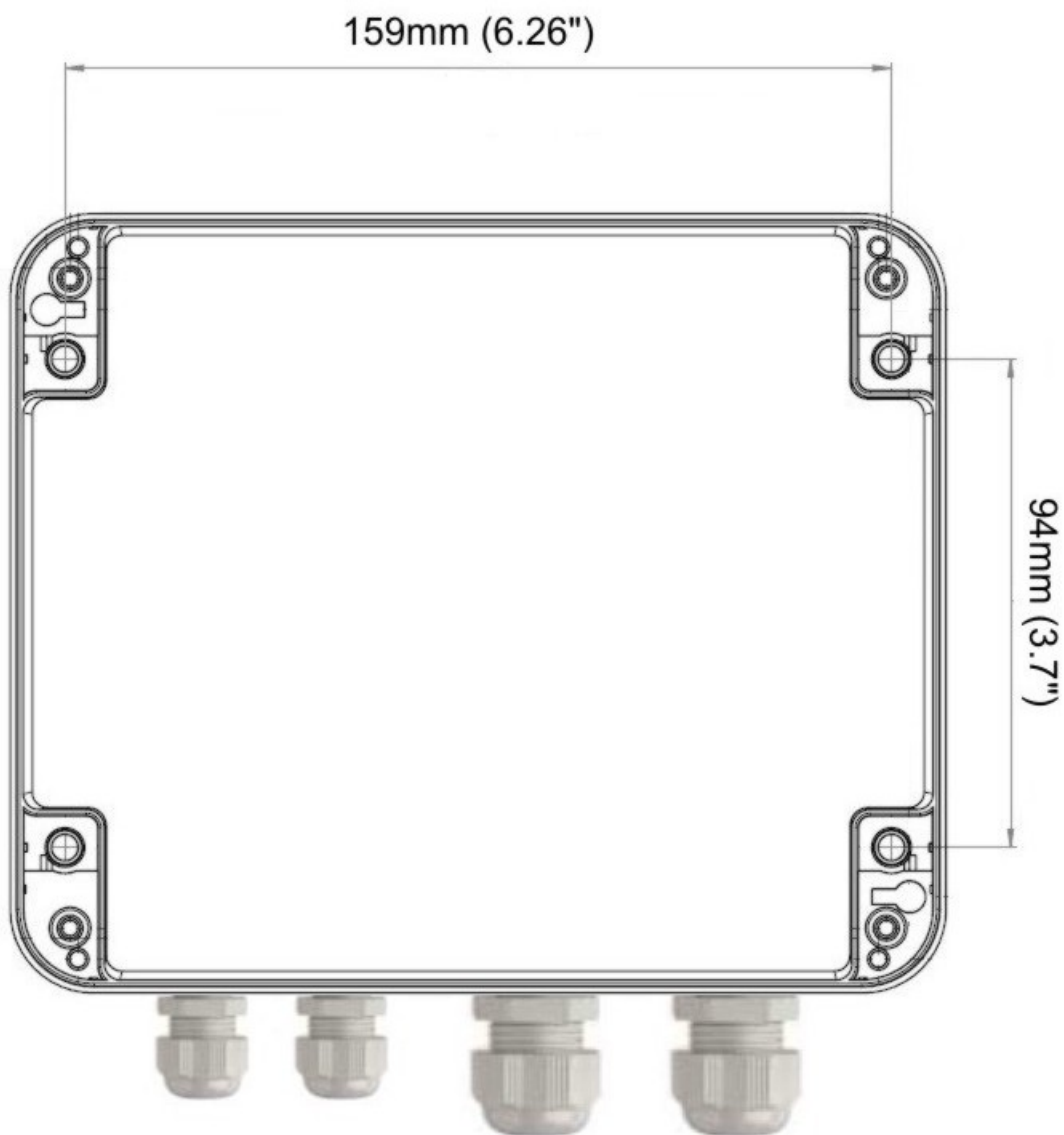

3.3 Opening the Unit

Make sure power to the unit has been removed before opening the unit.

To open the unit simply click open the 2 side cover strips and unscrew the 4 screws to remove the display part of the enclosure from the base part.

Make sure full anti-static precautions are adhered to when handling the circuit boards.

Do not apply power to the instrument until the instrument has been carefully reassembled back in to its enclosure.

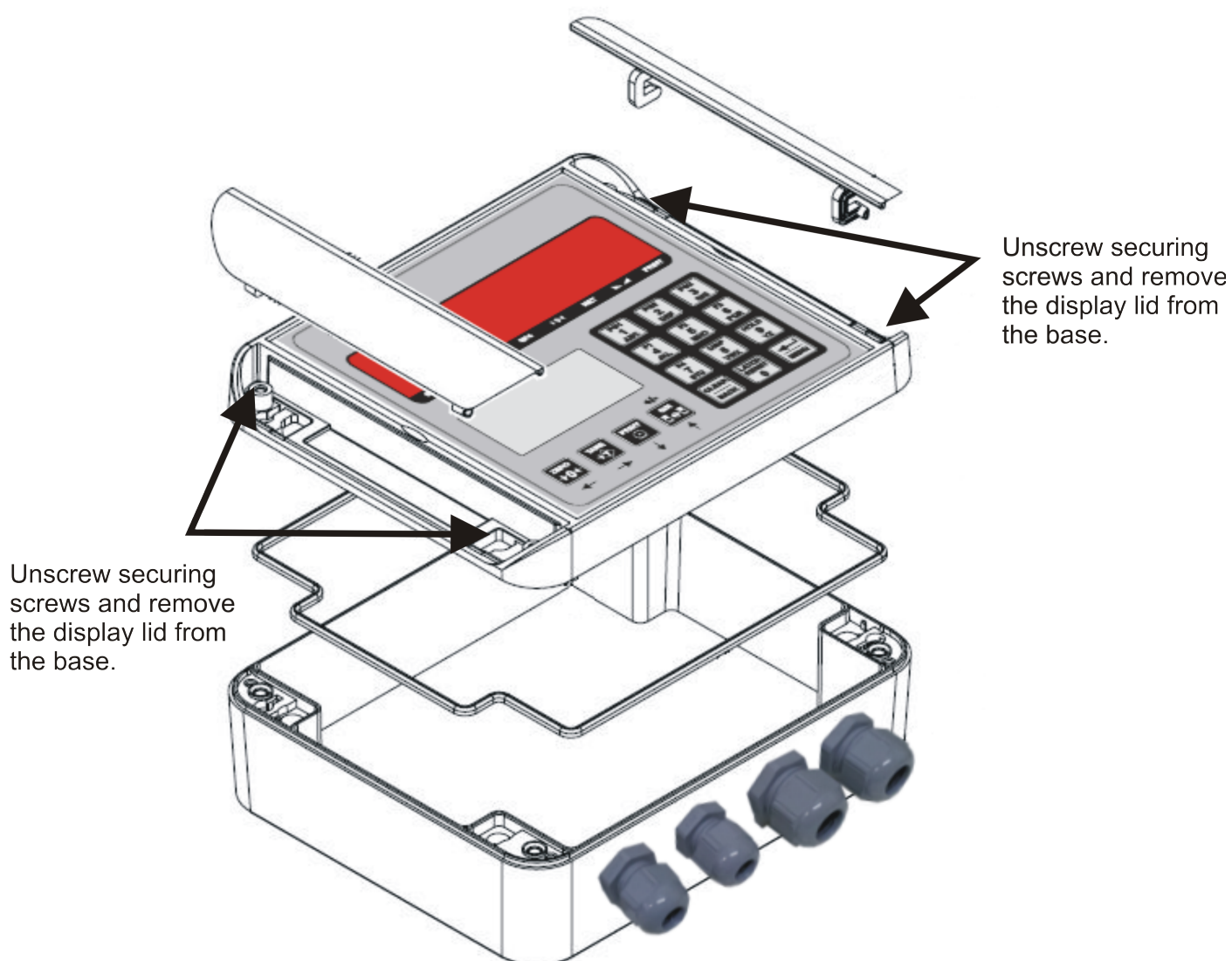

3.4 Hardware Connections, Jumpers and Fuse position

Below is an exploded view of the hardware connections and jumper locations of the main circuit board.

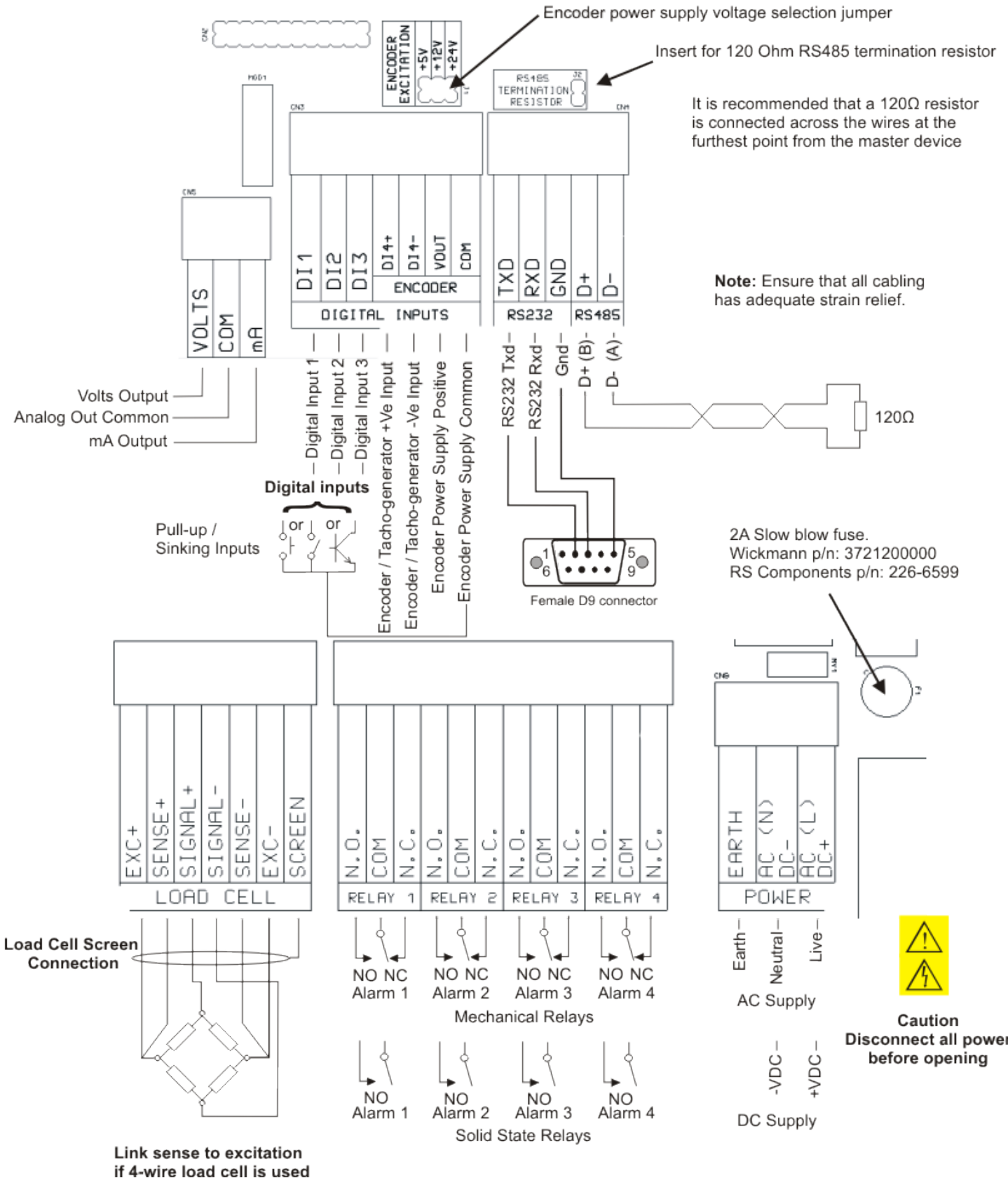

3.5 Power Supply Wiring

There are 3 different power supply variants! Please check which power supply is installed before connecting power by checking the sticker on the gland side of the instrument.

A universal mains switch mode power supply (85-264VAC) is provided as standard but an optional low voltage (10-30VDC) isolated power supply can be installed.

The instrument will consume a maximum of 10W with 6x350 ohm load cells, all relays on, mA analog output fully loaded, all led segments illuminated and the LCD backlight on.

WARNING - Access to power terminals should be restricted to authorised skilled personnel only. Application of supply voltages higher than those for which the instrument is intended may compromise safety and can cause permanent damage.

AC Power Supply

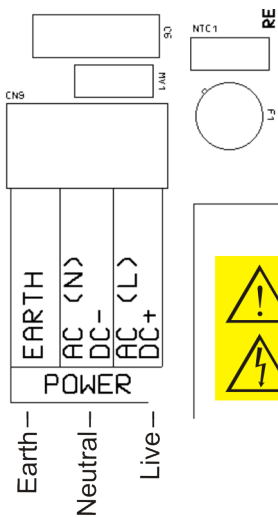

Caution
Disconnect all power
before opening

DC Power Supply

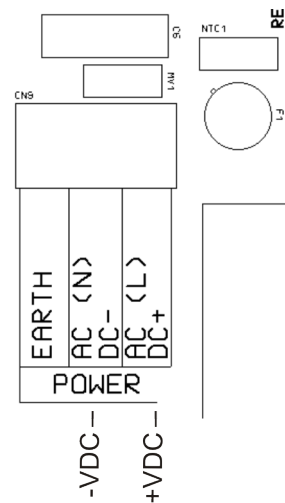

3.6 Fuse Replacement

The LT1320 contains a built in fuse. The fuse is a slow blow 2A Wickmann part number 3721200000. The fuse can also be purchased from RS Components part number 226-6599. The diagram below illustrates the position of the fuse on the main circuit board.

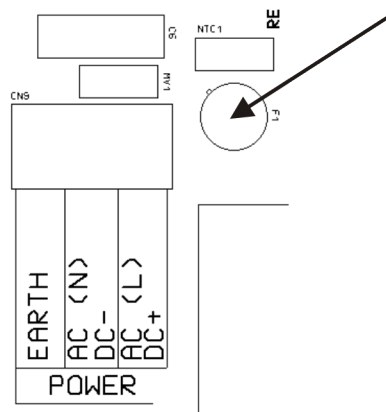

2A Slow blow fuse.
Wickmann p/n: 3721200000
RS Components p/n: 226-6599

3.7 Load Cell Connection

The load cell should be connected to the instrument as in the diagrams below. When making connection to the load cell make sure you use screened cable connected to a ground point at one side only. Avoid running cables in the same trunking as high current/voltage cables and cables supplying DC motors or contactors etc.

It is recommended to use 6-wire load cells for the best results. When using 6-wire load cells make sure you connect the sense+ and sense- wires as close as possible to the load cell. The sense lines compensate for any voltage loss due to the wiring impedance.

If using 4-wire load cells then the sense+ must be connected to the excitation+ and the sense- must be connected to the excitation- as close as possible to the instrument.

Automatic offset calibration

The LT1320 contains a unique feature in that it automatically does an offset calibration to cancel out any temperature effects in the electronics. This is to maintain optimum accuracy. The automatic offset calibration happens at power on as well as every few minutes. **Care must be taken to ensure that a load cell is connected before power is applied to the instrument otherwise an incorrect reading will be displayed until the next offset calibration takes place.**

4-Wire Load Cell Connection

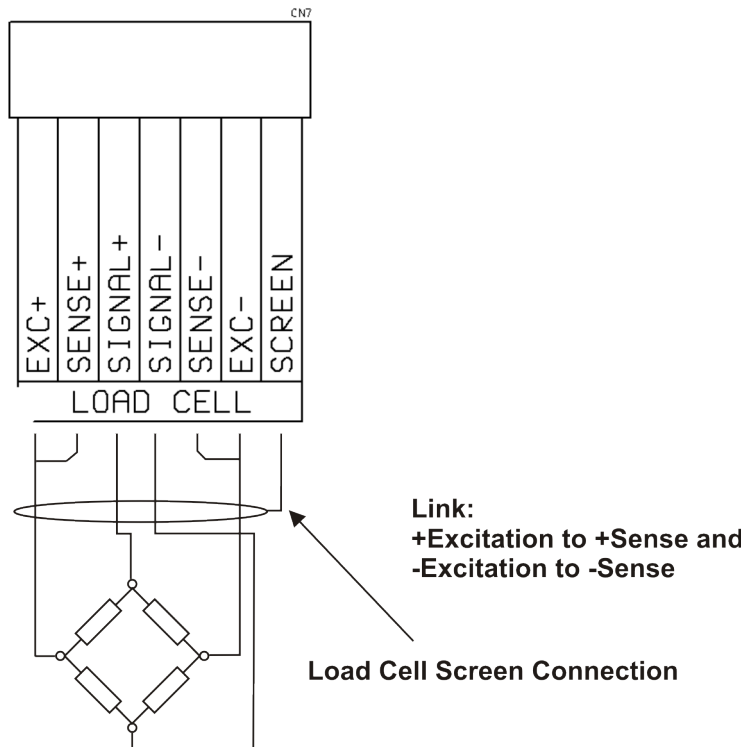

6-Wire Load Cell Connection

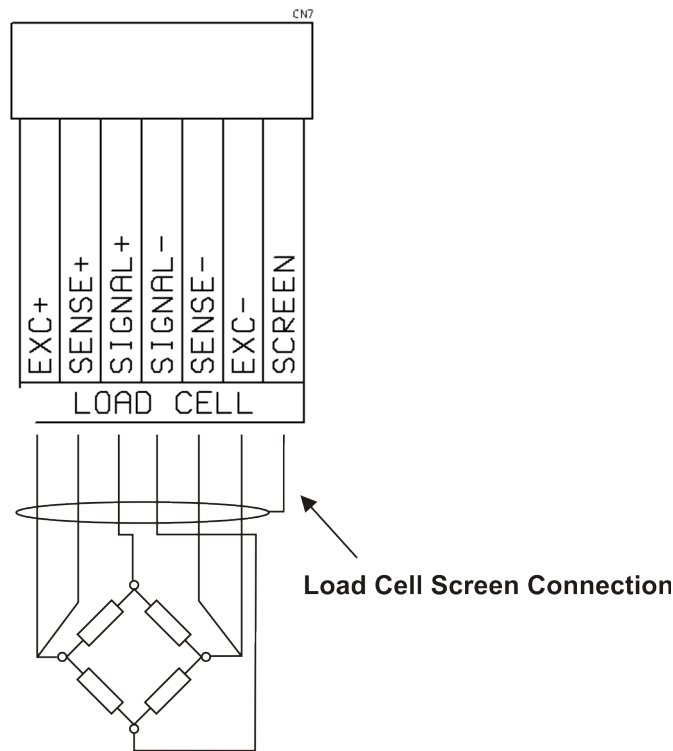

Millivolt (mV) only input

If the LT1320 is used as a millivolt meter or if a true mV output calibrator is used then the input must be connected as in the diagram below. This is necessary to maintain the common mode voltage for the ratiometric ADC.

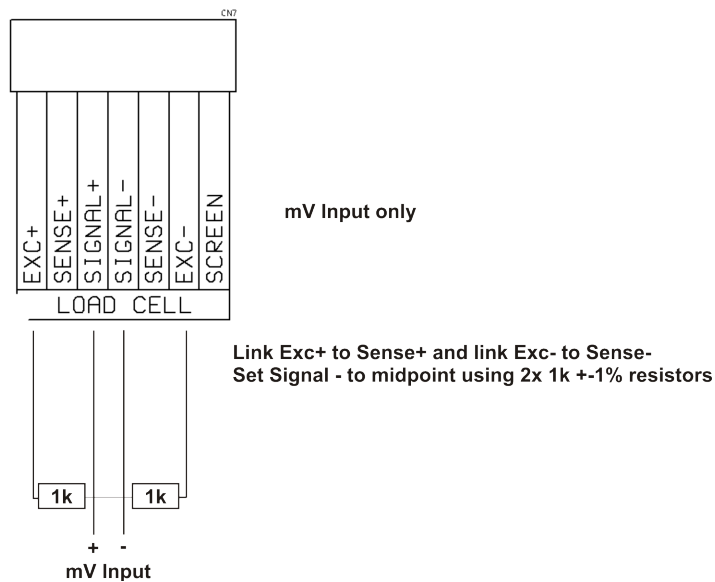

ADC Ratiometric input

The LT1320 uses a ratiometric ADC (Analog to Digital Converter) to obtain its precision. This means it uses the sense lines as the reference to the ADC. If the excitation voltage to the load cells varies (i.e. due to cable length, temperature etc) then the output voltage of the load cell will vary in proportion to the excitation voltage. This form of measurement improves the accuracy of the instrument and is perfectly suited for bridge circuits such as load cells.

Load Cell Excitation Voltage

The LT1320 provides a stable built in 5VDC load cell excitation voltage. The LT1320 can power up to 6x350Ω load cells using 5VDC excitation. Connect the sense+ to excitation+ and sense- to excitation- if using a 4-wire load cell.

3.8 Digital Input Connection

The LT1320 comes with 3 programmable digital inputs. The digital inputs can be used with either potential free contacts such as relay contacts, switches, transistor outputs or can be voltage driven. The inputs are not isolated from the instruments input circuitry. Each digital input line is pulled up to +5VDC with a 10kΩ resistor. Each digital input line has over voltage protection and input filtering with hysteresis. Digital input 4 is not used on the load cell indicator.

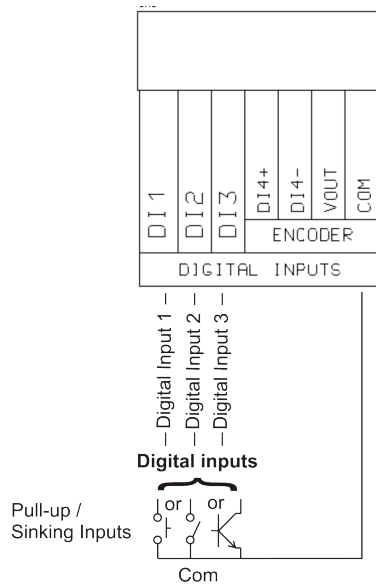

3.9 Encoder / Tacho-Generator Input Connection

The LT1320 has a pulse counting digital input to measure speed pulses from an encoder / tacho-generator. The encoder input is opto-isolated and is based on a PLC type input which can handle both NPN, Push-pull (Totem-Pole) and PNP encoders / tacho-generators. The LT1320 can handle frequencies up to 20KHz.

The LT1320 can also provide a stable +12Vdc or +24Vdc to power the encoder / tacho-generator. The encoder power supply voltage is jumper selectable with a maximum current consumption of 100mA.

Please see the diagrams below on how to connect the different types of encoders / tacho-generators.

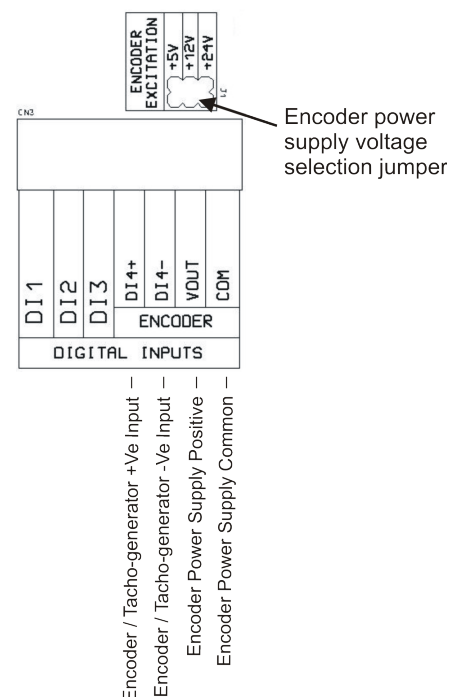

Encoder with NPN (Open Collector) or Totem-Pole (Push Pull) output

Encoder with NPN (Open Collector) output
Encoder with Totem-Pole (Push Pull) output

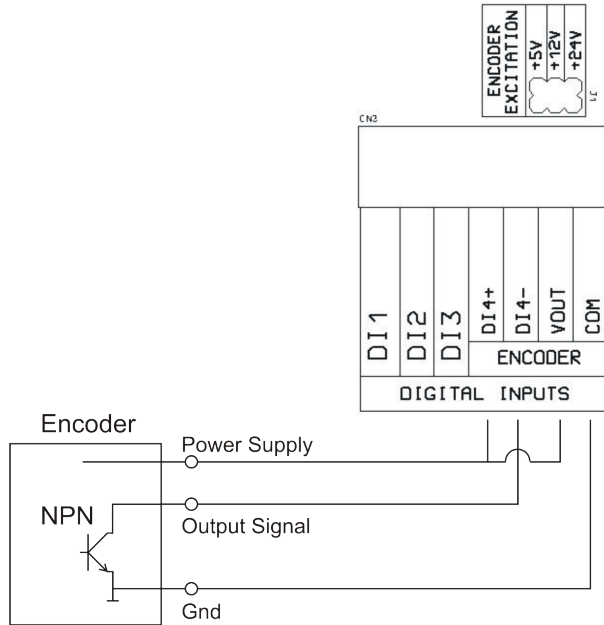

Encoder with PNP (Open Collector) output

Encoder with PNP (Open Collector) output

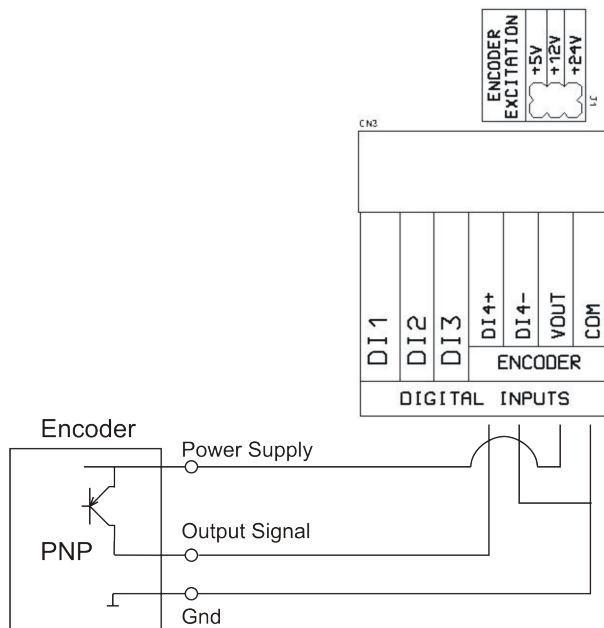

3.10 RS232 Communications

RS232 communications is standard on the LT1320. The RS232 protocol allows for a wired connection to be established as far as 100ft (30m). The RS232 port is also used for firmware upgrades.

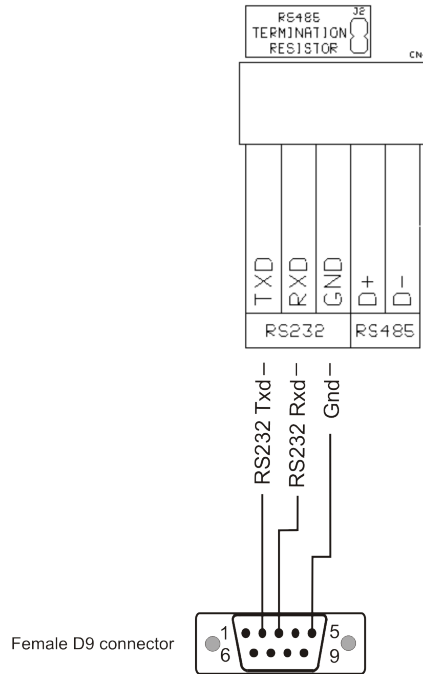

3.11 RS485 Communications

The RS485 protocol allows for a wired connection to be established as far as 4000ft (1200m). RS232 only allows for a wired connection up to 100ft (30m). The LT1320 includes an on-board termination resistor which can be selected by linking J2 on the main circuit board. The termination resistor is 120 Ohms.

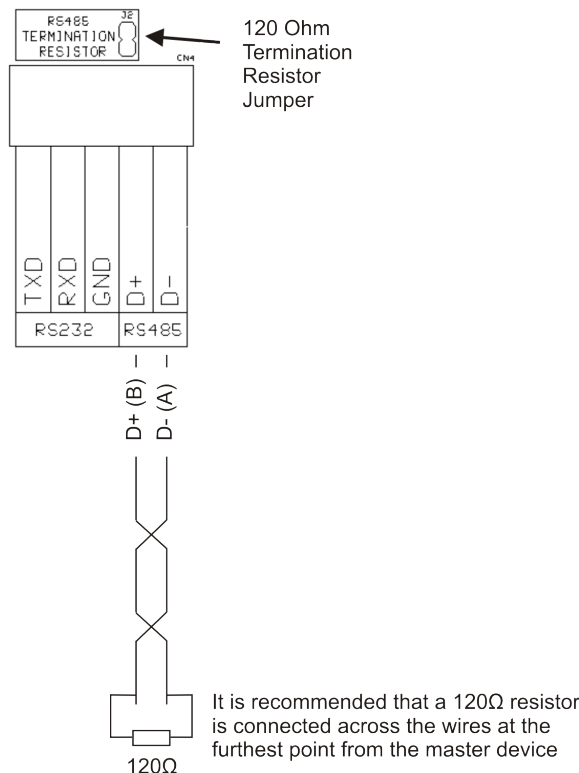

3.12 Mechanical Relays

4 Mechanical relays are provided as standard on the LT1320. Interposing relays are recommended for heavy duty applications. A R-C Snubber network or MOV maybe required for switching AC loads and a freewheeling diode or MOV maybe required for switching DC loads. An optional inductive load suppressor can be ordered and added to every relay output to suppress transient surges. Avoid running the alarm cables in the same trunking as the load cell cable.

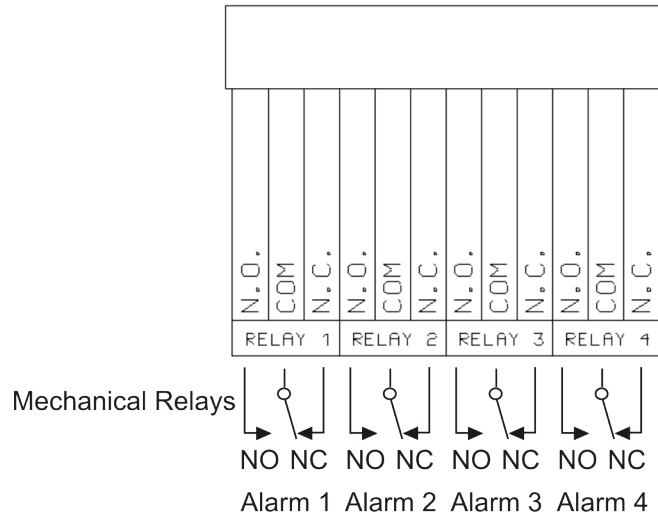

3.13 Solid-State Relays (Optional)

Up to 4 solid-state relays can be added as an option. These are factory fitted and take the position of the equivalent mechanical relay. Interposing relays are recommended for heavy duty applications. A R-C Snubber network or MOV maybe required for switching AC loads and a freewheeling diode or MOV maybe required for switching DC loads. An optional inductive load suppressor can be ordered and added to every relay output to suppress transient surges. Avoid running the alarm cables in the same trunking as the load cell cable.

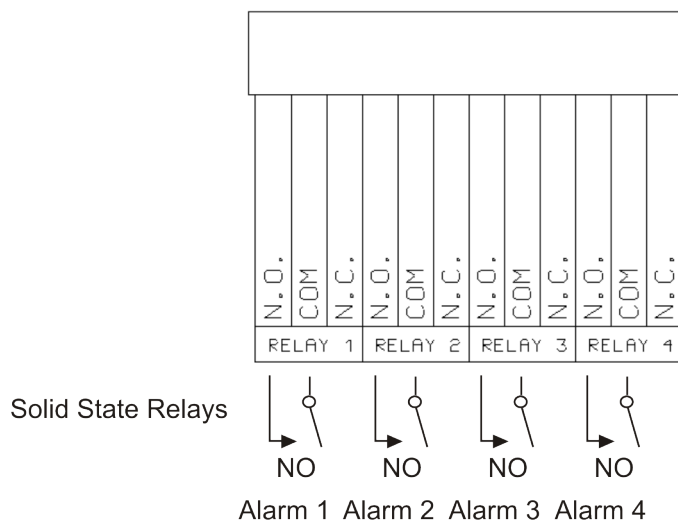

Noise suppression device for switching AC or DC devices

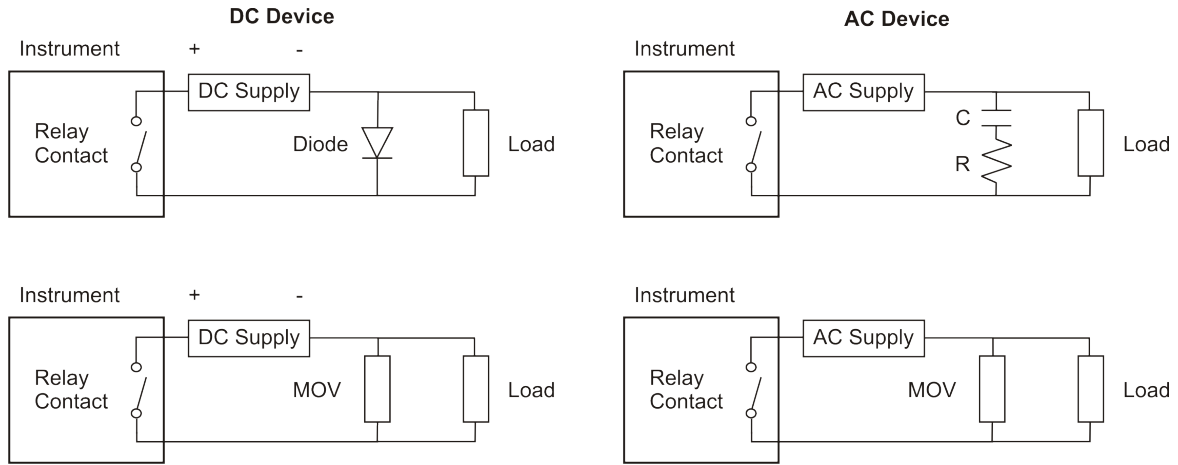

An optional noise suppression device can be ordered. Install these devices as close to the load as possible.

3.14 Analog Out / Isolated Analog Out (Optional)

The LT1320 has the analog output fitted as standard. The Analog output uses a high precision 16 bit DAC (Digital to Analog converter) to provide analog ranges of 0-20mA, 4-20mA and 0-10V. The current output is source, not sink and can drive a maximum of 500Ω. The voltage output can drive a minimum load of 1kΩ. The current output also has a unique open loop detection feature. If the current loop is broken then the words "LOOP ERROR" will be briefly displayed on the LCD display. Connect the analog output as in the diagram below. An optional isolated analog out can be fitted to the LT1320.



3.15 RTC Battery Replacement

The internal battery will have to be replaced if the LT1320 loses its time when the instrument is switched off and on. The battery is of type CR2032. The battery is located on the underside of the display circuit board. The diagram below shows the location of the battery.

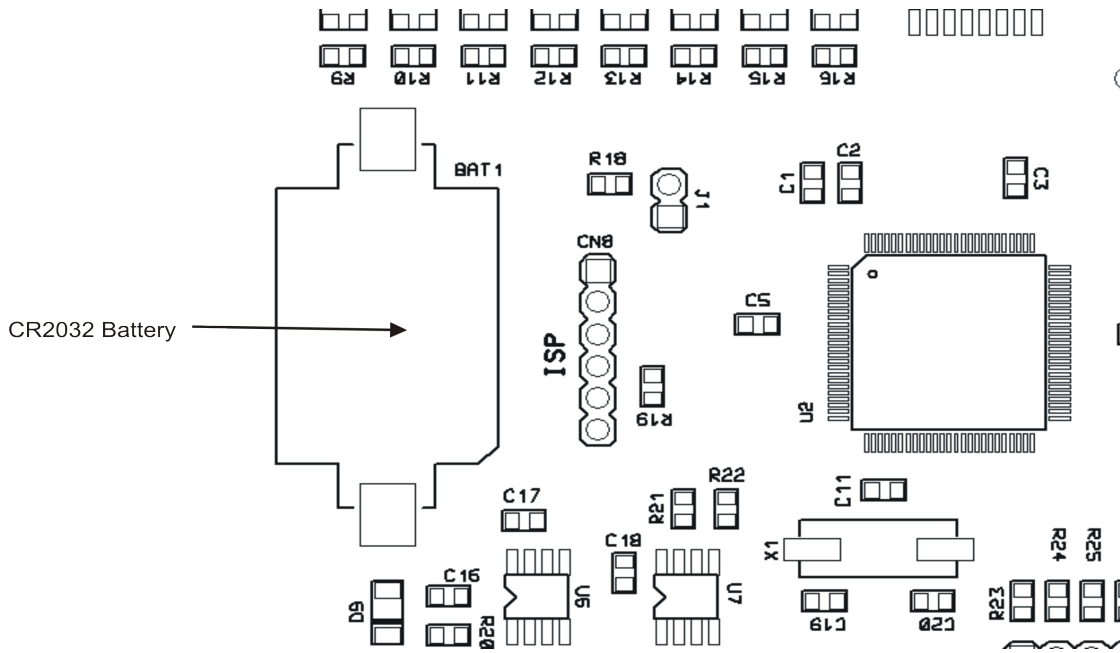

3.16 EMI Installation Guidelines

The instrument is designed with a high degree of immunity to EMI but the following guidelines will help in the successful installation of the instrument in the industrial environment. Cable length, routing and shielding can mean the difference between a successful or troublesome installation.

- Signal and control cables should be routed as far away as possible from contactors, DC motors etc.
- Never run signal or control cables in the same trunking as AC power lines or high current carrying conductors.
- Cables should be run in metal conduit that is grounded.
- Do not run cable near powerful radio transmitting devices eg. Two way radios.
- Keep cables as short as possible. Long cable runs are more susceptible to EMI then short run cables.
- Switching inductive loads cause high EMI. Use R-C Snubber networks or transient suppression devices across inductive loads.
- The instrument should be mounted in a grounded metal enclosure.
- Use shielded cables for all connections to the instrument. Some applications could require that one side of the screen is grounded.
- The use of external EMI suppression devices are recommended in high noise environments.

4 Front Panel Layout

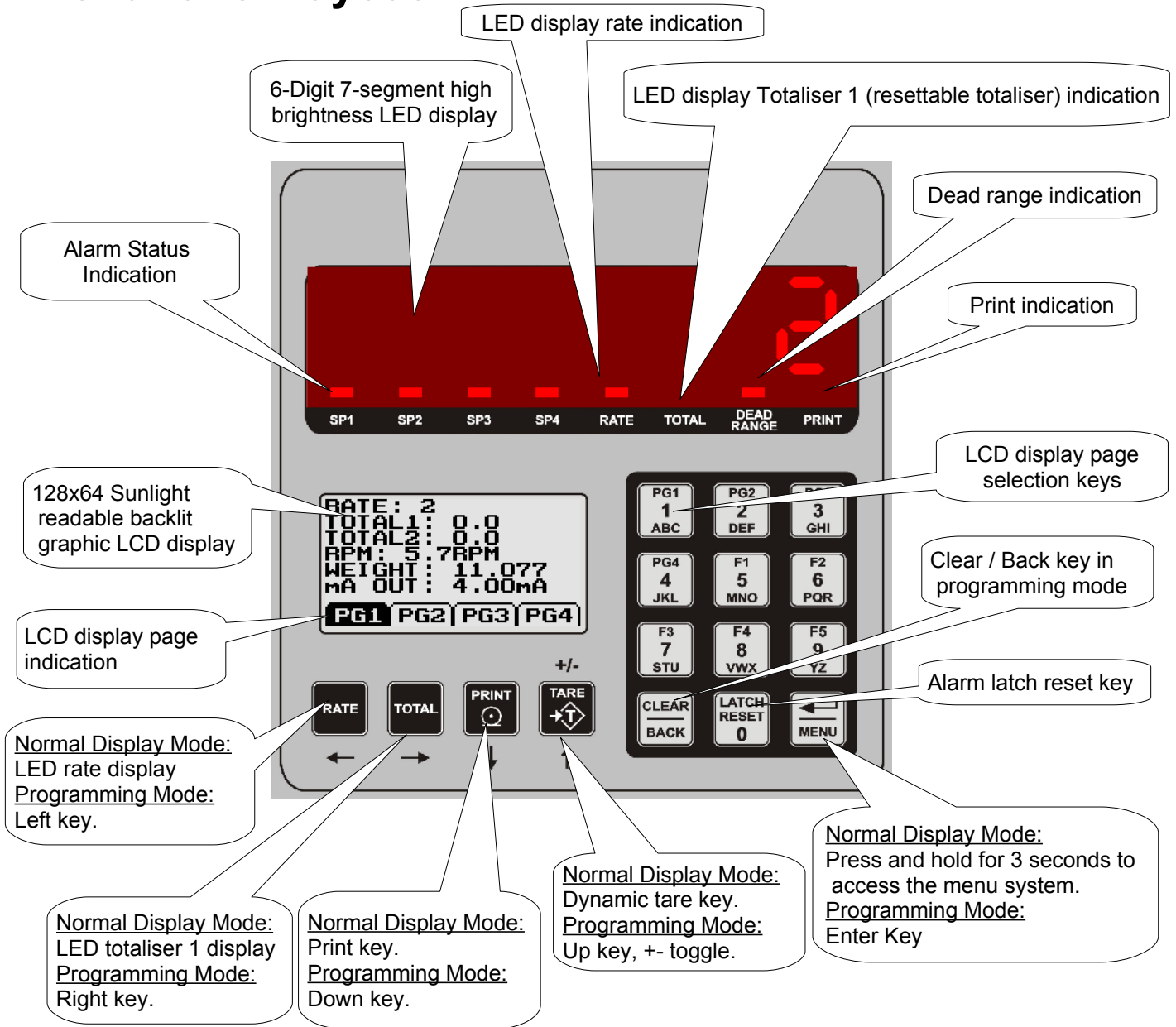

4.1 LED Status Indicators



The SP1 to SP4 LED will illuminate when the corresponding alarm has been activated.



The rate LED will illuminate when the LED display is showing the rate value.



The total LED will illuminate when the LED display is showing the totaliser 1 (resettable totaliser) value.



The dead range LED will illuminate when the rate value is below the dead band setting. The rate value will not be added to the totalisers when the dead range LED is illuminated.





The Print LED will briefly flash when a successful print has been completed.

4.2 Keyboard Description

The LT1320 contains 4 dedicated function keys which can be enabled in the Function Key menu option. During normal display mode these are:

- 

This is the LED display rate push button. If enabled, this will switch the LED display to show the rate value.
- 

This is the LED display totaliser 1 (resettable totaliser) push button. If enabled, this will switch the LED display to show the totaliser 1 value.
- 

This is the print push button. If enabled, this function key allows the user to print the assigned value via the RS232 or the RS485 interface. The print LED will briefly illuminate when the print push button is pressed. The print button will only work if either the RS232 or RS485 ASCII Out mode is selected.
- 

This is the dynamic tare push button. If enabled, this function key will start the dynamic tare function of the belt conveyor system.

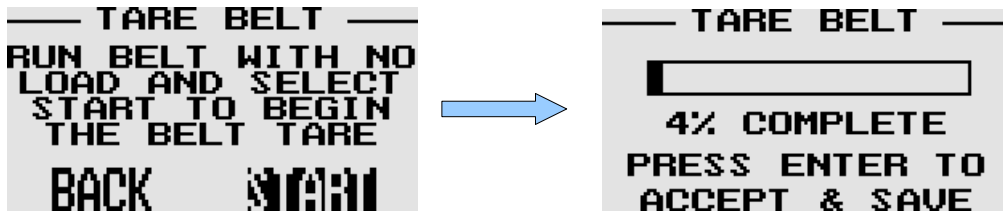



 These keys also serve as the up, down, left, right keys when navigating the menu system. The up key also changes the sign of a value when in editing a numeric value.

Keypad

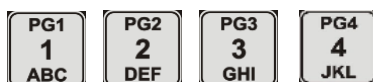

The LT1320 contains a full alpha-numeric keypad for data entry in programming mode. During the normal display mode certain keys have alternate functions. These are:



These keys select page 1, page 2, page 3 or page 4 on the LCD display.

- 

This is the alarm latch push button. If enabled, this function key will reset any of the latched alarms when the alarm condition has been removed. This menu option is only displayed if any of the alarm latch functions have been enabled.

4.3 LCD Display Pages

LCD Display Page 1

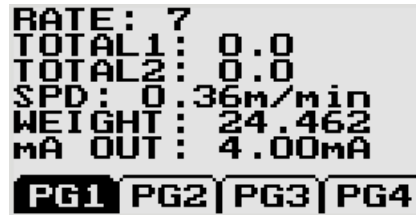

This display page shows the following parameters: Rate, Totaliser 1 (resettable totaliser), Totaliser 2 (non-resettable totaliser), Speed / RPM / frequency, Weight / Tare value and the analog out value. When the LT1320 is measuring the belt speed via the encoder / tachogenerator input then the speed value will alternate to display RPM and frequency. The weight and tare value share the same line and will alternate at a set time interval.

LCD Display Page 2



This display page shows the Totalisers. Totaliser 1 (resettable totaliser) and Totaliser 2 (non-resettable totaliser). Press the clear key to reset the Totaliser 1 value to zero.

LCD Display Page 3



This display page shows the setpoints. This page also allows the editing of the setpoint values (If enabled in the security setup)

LCD Display Page 4



This display page shows the max values. Press the clear button to reset the max values to the current values.

5 Menu System

5.1 Main Menu

The main menu is entered by pressing and holding down the  key for 3 seconds. The following menu items will be displayed.

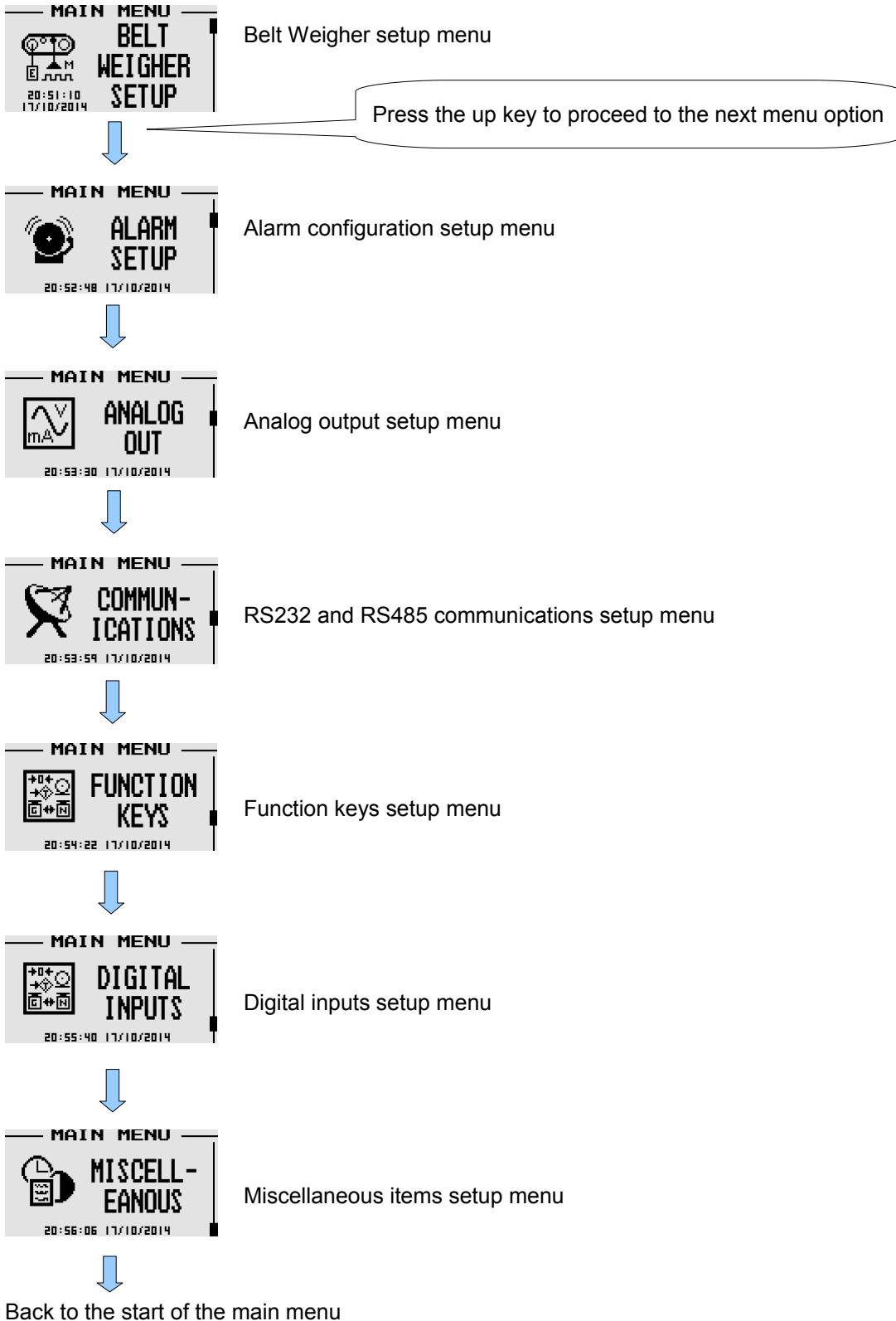

5.1.1 Exiting the menu system



Press the  key when the main menu items are showing to exit the menu system. All the settings are saved and the instrument will then return to the normal display mode.

Note: The menu system has a 2 minute program timeout. If no key has been pressed within this period then the instrument will save all settings and return to the normal display mode.

5.2 Belt Weigher Setup Menu



This menu configures the Belt Weigher parameters and also allows the user to calibrate the load cells.

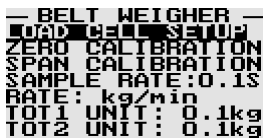

This sub-menu configures the load cell parameters and also allows the user to calibrate the load cell system.

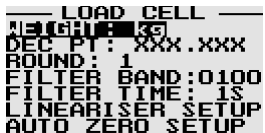

Select the weight unit. The weight unit can be selected from “kg” kilograms, “t” metric tonnes, “lb” pounds and “T” imperial tons.

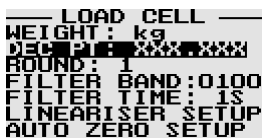

Select the weight decimal point.

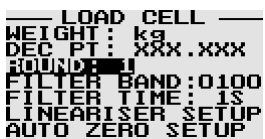

Select the display rounding in display counts. The round function rounds the display value to the nearest rounding increment. Eg. With a rounding setting of “5”, a display value of 233 will be rounded up to 235. A setting of “10” will create a dummy zero. The display rounding function can be used in conjunction with the digital filter settings to create a more stable display in noisy environments. The display rounding can be selected from “1”, “2”, “5”, “10”, “20”, “50”, “100” or “200” display counts.



5.2.1 Advanced Digital Filtering

The LT1320 instrument contains an advanced digital filter algorithm. The filter works by filtering small changes between measurements but will react instantaneously to a large step response. There are 2 settings that are used to setup the digital filter, namely the filter band and the filter time. The filter band is the threshold in counts that the value must change by in order for the instrument to recognise it as a step response. The display will jump to this value immediately if a step response is detected. The filter time is the time in seconds that the input signal will be filtered provided that the input remains within the filter band setting. The filter is achieved by taking the moving average of the input signal for the filter time setting.

An increase in filter time leads to a more stable display but with a reduced reaction time. Use the filter time in conjunction with the filter band and display rounding settings to create a tradeoff between reaction time and display stability.

The diagram below illustrates the use of the filter time and the filter band.

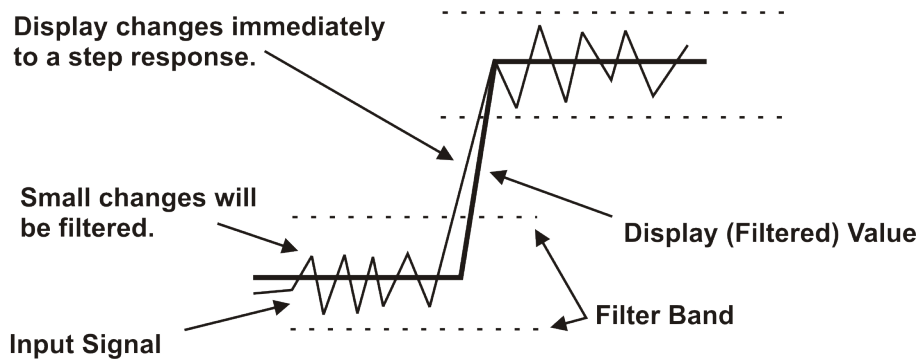

```

LOAD CELL
WEIGHT: kg
DEC PT: XXX.XXX
ROUND: 1
FILTER BAND: 0.100
FILTER TIME: 1S
LINEARISER SETUP
AUTO ZERO SETUP
    
```

See the paragraph above for an explanation of the filter band.



```

LOAD CELL
WEIGHT: kg
DEC PT: XXX.XXX
ROUND: 1
FILTER BAND: 0.100
FILTER TIME: 3S
LINEARISER SETUP
AUTO ZERO SETUP
    
```

Select the filter time. See the paragraph above for an explanation of the filter time. A value of "1", "3", "5" or "10" seconds can be selected.



```

LOAD CELL
WEIGHT: kg
DEC PT: XXX.XXX
ROUND: 1
FILTER BAND: 0.100
FILTER TIME: 1S
LINEARISER SETUP
AUTO ZERO SETUP
    
```

Lineariser setup sub-menu

For non-linear processes, up to 16 scaling points may be used to provide a piece-wise linear approximation. The greater the number of points the greater the accuracy. Each point has a real value and a corresponding display value. The real value is the actual value of the input as it would be with the lineariser feature turned off, the display value is the desired value.

Setup the lineariser as follows:

- The instrument must be setup and calibrated as normal.
- Apply test signals and record the actual readings on the display.
- Activate the lineariser and enter the real values and its corresponding display/desired value.
- The instrument can be checked by applying the original test signal and verifying the display value.

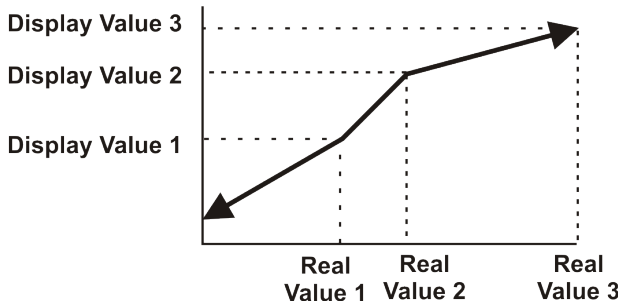

Note:
 If the measured value is above the last actual point then the lineariser will use the last 2 points to calculate the slope and similarly if the measured value is below the first actual point then it will use the first 2 points to calculate the slope.

```

    --- LINEARISER ---
    ENABLE: ON
    POINTS: 3
    REAL 1: +000.000
    DISP 1: +000.000
    REAL 2: +000.100
    DISP 2: +000.200
    REAL 3: +000.200
    
```

Select to enable the lineariser feature.



```

    --- LINEARISER ---
    ENABLE: ON
    POINTS: 3
    REAL 1: +000.000
    DISP 1: +000.000
    REAL 2: +000.100
    DISP 2: +000.200
    REAL 3: +000.200
    
```

Select the number of lineariser scaling points.



```

    --- LINEARISER ---
    ENABLE: ON
    POINTS: 3
    REAL 1: +000.000
    DISP 1: +000.000
    REAL 2: +000.100
    DISP 2: +000.200
    REAL 3: +000.200
    
```

Enter the actual or real value.



```

    --- LINEARISER ---
    ENABLE: ON
    POINTS: 3
    REAL 1: +000.000
    DISP 1: +000.000
    REAL 2: +000.100
    DISP 2: +000.200
    REAL 3: +000.200
    
```

Enter the display or desired value.



Back to the start of the lineariser setup menu

```

LOAD CELL
WEIGHT: kg
DEC PT: XXX.XXX
ROUND: 1
FILTER BAND: 0100
FILTER TIME: 1S
LINEARISER SETUP
AUTO ZERO SETUP
    
```

Auto-Zero Tracking sub-menu

The auto-zero tracking feature will zero the weight display at regular intervals as long as the measured weight is within the zero band setting. The LCD display will briefly flash "AUTO-ZERO" when an auto-zero has been performed. When the instrument restarts, the auto zero correction is lost, but it will start again with a new auto zero correction. Manual zeroing can also be done via a front push button or via a rear digital input. The auto-zero tracking function can be used to compensate for zero drift. Zero drift may be caused by changes in the electronics or accumulation of material on the weight system. The auto-zero band should be set large enough to track normal zero drift, but small enough not to interfere with normal measuring.

The diagram to the right illustrates the use of the auto-zero tracking function.

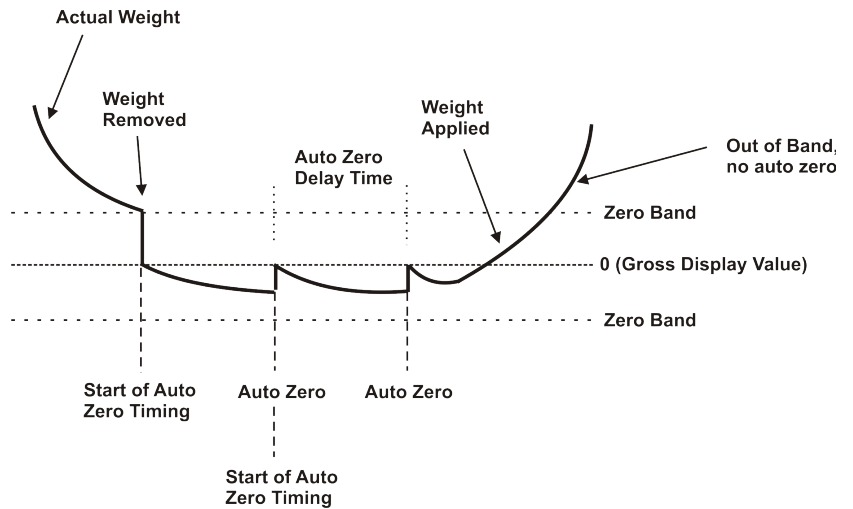

```

AUTO ZERO SETUP
ENABLE: ON
ZERO BAND: 100
DELAY: 600
    
```

Select to enable the auto-zero tracking feature.



```

AUTO ZERO SETUP
ENABLE: ON
ZERO BAND: 100
DELAY: 600
    
```

Enter the zero band setting in display counts. The auto-zero tracking will work within the limits of this band.



```

AUTO ZERO SETUP
ENABLE: ON
ZERO BAND: 100
DELAY: 600
    
```

Auto-zero tracking delay time. This defines how often an auto zero is attempted.



Back to the start of the auto zero setup menu

```

— BELT WEIGHER —
LOAD CELL SETUP
ZERO CALIBRATION
SPAN CALIBRATION
SAMPLE RATE:0.1S
RATE: kg/min
TOT1 UNIT: 0.1kg
TOT2 UNIT: 0.1kg
    
```

Zero Calibration sub-menu. The zero calibration is done to show a zero reading when there is no material on the belt system. The zero calibration is done by removing any deadweight from the belt itself and the weigh section. Make sure the belt system is running and that and that at least 1 full revolution of the belt has been achieved when doing the zero calibration feature.

The “L DISP” and “L MV/V” values do not need to be entered manually if the user is performing a dynamic zero calibration using the “START ZERO CAL”.

For best results the system should be given a warm up time of a minimum of 15 minutes before calibration takes

```

— ZERO CAL —
L DISP: +000.000
L MV/V: +00.0000
START ZERO CAL
    
```

Enter the value in engineering units of the low calibration point of the system. This is normally zero.



```

— ZERO CAL —
L DISP: +000.000
L MV/V: +00.0000
START ZERO CAL
    
```

Enter the value in mV/V that corresponds to the low display value. This value is normally found on the load cells calibration certificate. The load cells offset zero error is normally expressed as uV (microvolts) at 10V excitation. Eg. A load cell zero error with no load is 560uV (0.56mV) at 10V excitation. To convert to mV/V divide by 10 which equals 0.056mV. This value must then be entered into the low mV/V setting.



```

— ZERO CAL —
L DISP: +000.000
L MV/V: +00.0000
START ZERO CAL
    
```

Select this menu item to perform a dynamic zero calibration of the belt system.



```

— ZERO CAL —
RUN BELT WITH NO
LOAD AND SELECT
START TO BEGIN
THE ZERO CAL
BACK
    
```

Select start to begin the dynamic zero calibration procedure.



```

— ZERO CAL —
██████████
11% COMPLETE
PRESS ENTER TO
ACCEPT & SAVE
    
```

Press enter to accept the zero calibration. Make sure the belt system is running and that and that at least 1 full revolution of the belt has been achieved when doing the zero calibration feature. The averaging time of the conveyor belt can be extended by increasing the sample time setting.



```

— MESSAGE —
! DONE
    
```

Done! The belt conveyor system can now be stopped. The zero calibration value and its corresponding mV/V value will be saved in “L DISP” and “L MV/V” settings.

Back to the start of the zero calibration menu

```

-- BELT WEIGHER --
LOAD CELL SETUP
ZERO CALIBRATION
SPAN CALIBRATION
SAMPLE RATE: 0.1s
RATE: kg/min
TOT1 UNIT: 0.1kg
TOT2 UNIT: 0.1kg
    
```

Span Calibration sub-menu

Place the test weights on the weigh section of the belt conveyor.

The “H DISP” and “H MV/V” values do not need to be entered manually if the user is performing a calibration using test weights and using the “START SPAN CAL”.

For best results the system should be given a warm up time of a minimum of 15 minutes before calibration takes

```

-- SPAN CAL --
H DISP: +020.000
H MV/V: +02.0000
START SPAN CAL
    
```

Enter the value in engineering units of the high calibration point of the system eg. 5000kg. This is normally the full rating value of the load cells.



```

-- SPAN CAL --
H DISP: +020.000
H MV/V: +02.0000
START SPAN CAL
    
```

Enter the value in mV/V that corresponds to the high display value. This value is normally found on the load cells calibration certificate. The required value is the rated value of the load cell in mV/V at full load.



```

-- SPAN CAL --
H DISP: +020.000
H MV/V: +02.0000
START SPAN CAL
    
```

Select this menu item to perform a span calibration of the belt system. This allows the user to enter and apply the high load cell calibration weight.

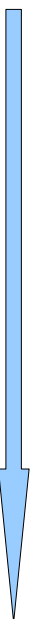

```

-- SPAN CAL --
APPLY A KNOWN
WEIGHT APPROX
100% AND ENTER
THE VALUE
+020.000 kg
    
```

Apply the test weight to the weigh section and enter the display value that corresponds to the test weight.



```

-- SPAN CAL --
5% COMPLETE
PRESS ENTER TO
ACCEPT & SAVE
    
```

The LT1320 will start to average and calculate the mV/V value that corresponds to the test weight.



```

-- MESSAGE --
! DONE
    
```

Done! The test weight can now be removed. The high calibration value and its corresponding mV/V value will be saved in “H DISP” and “H MV/V” settings.

Back to the start of the span calibration menu

Notes on calibration:

The LT1320 span calibration can be calibrated in 2 ways. Either by using test weights or from the load cell calibration certificate. The LT1320 can be calibrated using the mV/V values from the load cell calibration certificate and entering this in the “H DISP” and “H MV/V” settings.

For best results the system should be given a warm up time of a minimum of 15 minutes before calibration takes place and the 2 known weights should be as different from each other as possible to allow the LT1320 to try and obtain the greatest resolution. The high calibration test weight should also be as close to the maximum system capacity as possible (Full load on the load cells)

Calibrating using a Load Cell Simulator or mV simulator

Calibrating the LT1320 using a known test weight is the most accurate way to calibrate the instrument. Other calibration equipment such as a load cell simulator or mV calibrator can also be used.

Using a load cell simulator is the easiest and best way to calibrate the LT1320 and this requires no additional interface circuitry because the load cell simulator will setup the common mode voltage required by the input to the ADC.

The circuit as illustrated to the right must be constructed if trying to calibrate the LT1320 using a pure mV signal such that of a pure mV output calibrator. The resistors can be of a type 1k Ohm 1/4W 50ppm 1%. Please note that the resistor junction is only connected on the negative signal input. The below circuit is required to setup a common mode voltage for the ratiometric ADC.

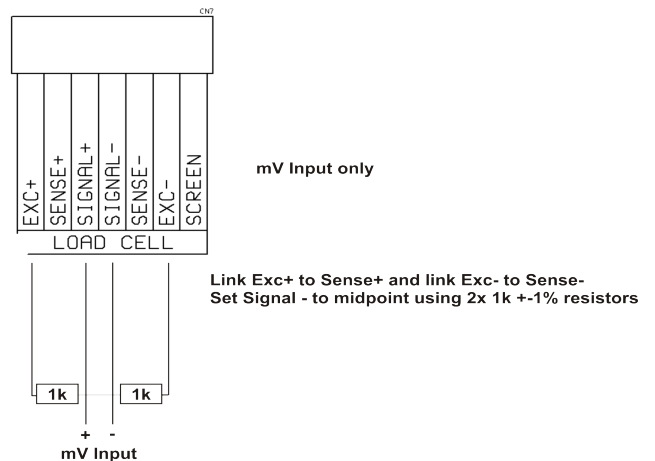

```

-- BELT WEIGHER --
LOAD CELL SETUP
ZERO CALIBRATION
SPAN CALIBRATION
SAMPLE RATE: 0.1S
RATE: kg/min
TOT1 UNIT: 0.1kg
TOT2 UNIT: 0.1kg
    
```

Select the sample rate of the analog to digital converter. This can extend the averaging time for the zero calibration, span calibration and dynamic tare of the belt system.



```

-- BELT WEIGHER --
LOAD CELL SETUP
ZERO CALIBRATION
SPAN CALIBRATION
SAMPLE RATE: 0.1S
RATE: kg/min
TOT1 UNIT: 0.1kg
TOT2 UNIT: 0.1kg
    
```

Select the belt rate unit. The units can be selected from “0.1kg/min”, “kg/min”, “0.01kg/h”, “0.1kg/h”, “kg/h”, “0.1t/min”, “t/min”, “0.01t/h”, “0.1t/h”, “t/h”, “0.1lb/min”, “lb/min”, “0.01lb/h”, “0.1lb/h”, “lb/h”, “0.1T/min”, “T/min”, “0.01T/h”, “0.1T/h” or “T/h”



```

-- BELT WEIGHER --
LOAD CELL SETUP
ZERO CALIBRATION
SPAN CALIBRATION
SAMPLE RATE: 0.1S
RATE: kg/min
TOT1 UNIT: 0.1kg
TOT2 UNIT: 0.1kg
    
```

Select the totaliser 1 unit. The units can be selected from “0.1kg”, “kg”, “0.001t”, “0.01t”, “0.1t”, “t”, “0.1lb”, “lb”, “0.01T”, “0.1T” or “T”.



```

-- BELT WEIGHER --
LOAD CELL SETUP
ZERO CALIBRATION
SPAN CALIBRATION
SAMPLE RATE:0.1S
RATE: kg/min
TOT1 UNIT: 0.1kg
TOT2 UNIT: 0.1kg
    
```

Select the totaliser 2 unit. The units can be selected from “0.1kg”, “kg”, “0.001t”, “0.01t”, “0.1t”, “t”, “0.1lb”, “lb”, “0.01T”, “0.1T” or “T”.



```

-- BELT WEIGHER --
ZERO CALIBRATION
SPAN CALIBRATION
SAMPLE RATE:0.1S
RATE: kg/min
TOT1 UNIT: 0.1kg
TOT2 UNIT: 0.1kg
WEIGH LEN: 01000
    
```

Enter the weigh section length of the belt weigher in millimeters (mm). See examples below.



1 Roller on load cells

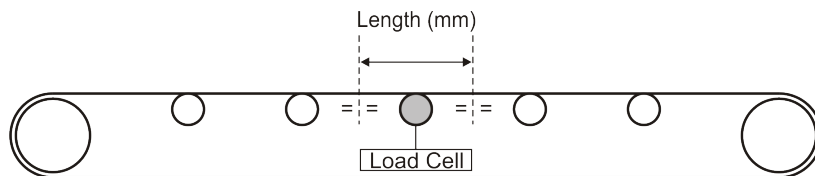

2 Rollers on load cells

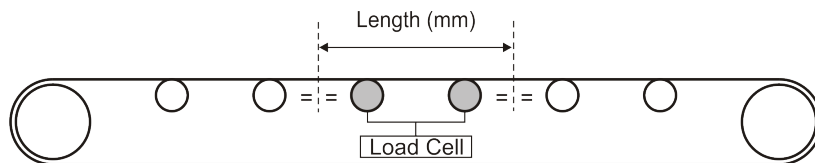

3 Rollers on load cells

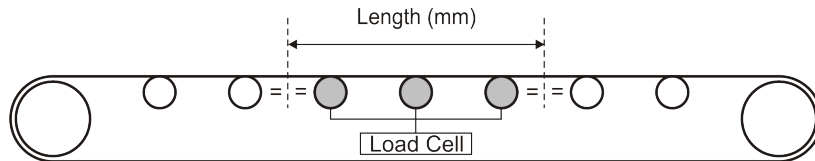

Complete conveyor on load cells

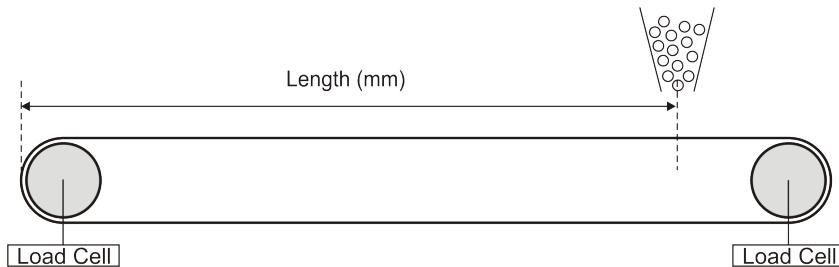

```

-- BELT WEIGHER --
SPAN CALIBRATION
SAMPLE RATE:0.1S
RATE: kg/min
TOT1 UNIT: 0.1kg
TOT2 UNIT: 0.1kg
WEIGH LEN: 01000
DEAD BAND: 010
    
```

Enter the dead band limit. Any belt rate value under this value will not be added to the totalisers.



```

-- BELT WEIGHER --
SAMPLE RATE: 0.1S
RATE: kg/min
TOT1 UNIT: 0.1kg
TOT2 UNIT: 0.1kg
WEIGH LEN: 01000
DEAD BAND: 010
C-FACTOR: 100.0%
BELT SPEED: MEAS
    
```



Enter the rate correction factor in percent. This factor adjusts the rate value proportionally and can fine tweak the rate value of the system.

```

-- BELT WEIGHER --
RATE: kg/min
TOT1 UNIT: 0.1kg
TOT2 UNIT: 0.1kg
WEIGH LEN: 01000
DEAD BAND: 010
C-FACTOR: 100.0%
BELT SPEED: SET
    
```



Select if you want to manually enter a belt speed or if you want the belt weigher to measure the belt speed using the encoder / tacho-generator input.

If the Belt Speed is set to "SET"

```

-- BELT WEIGHER --
TOT1 UNIT: 0.1kg
TOT2 UNIT: 0.1kg
WEIGH LEN: 01000
DEAD BAND: 010
C-FACTOR: 100.0%
BELT SPEED: SET
PULLEY DIA: 0100
    
```

Enter the average belt speed in m/min.

If the Belt Speed is set to "MEAS"

```

-- BELT WEIGHER --
TOT1 UNIT: 0.1kg
TOT2 UNIT: 0.1kg
WEIGH LEN: 01000
DEAD BAND: 010
C-FACTOR: 100.0%
BELT SPEED: MEAS
PULLEY DIA: 0100
    
```

Enter the pulley diameter including the belt thickness top and bottom in millimeters (mm).



```

-- BELT WEIGHER --
TOT2 UNIT: 0.1kg
WEIGH LEN: 01000
DEAD BAND: 010
C-FACTOR: 100.0%
BELT SPEED: MEAS
PULLEY DIA: 0100
ENC PUL/REV: 0600
    
```

Enter the pulses per revolution of the encoder / tacho-generator



```

-- BELT WEIGHER --
WEIGH LEN: 01000
DEAD BAND: 010
C-FACTOR: 100.0%
BELT SPEED: MEAS
PULLEY DIA: 0100
ENC PUL/REV: 0600
FREQ MEAS: >500Hz
    
```

Select if you want to measure frequency using period measurement "<500Hz" or pulse measurement ">500Hz".



```

-- BELT WEIGHER --
DEAD BAND: 010
C-FACTOR: 100.0%
BELT SPEED: MEAS
PULLEY DIA: 0100
ENC PUL/REV: 0600
FREQ MEAS: <500Hz
FREQ FILTER: 2S
    
```

This menu item is only shown if the frequency measurement is set for "<500Hz". This menu item selects the filter time of the frequency input.

```

-- BELT WEIGHER --
DEAD BAND: 010
C-FACTOR: 100.0%
BELT SPEED: MEAS
PULLEY DIA: 0100
ENC PUL/REV: 0600
FREQ MEAS: >500Hz
FREQ GATE: 1S
    
```

This menu item is only shown if the frequency measurement is set for ">500Hz". This menu item selects the gate time interval for the frequency pulse counting.



Back to the start of the belt weigher configuration menu

5.3 Alarm Configuration Menu



This menu configures the alarm parameters.

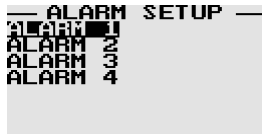

The Alarm 1 setup menu is shown below. The setup menu is identical for each of the alarms.



Select the alarm mode. The alarm mode can be set to:

- “OFF”: The alarm is disabled
- “LOW”: A low alarm is activated when the measured value is below the alarm setpoint.
- “HIGH”: A high alarm is activated when the measured value is higher then the alarm setpoint
- “DEV” A deviation alarm which is activated when the measured value falls outside of the deviation band.
- “PULSE TOT 1” Pulse output using totaliser 1.
- “PULSE TOT 2” Pulse output using totaliser 2.



Select the alarm assignment. The alarm will use this value to compare against the set point value. The alarm can be selected to work off the “WEIGHT”, “RATE”, “TOTAL 1”, “TOTAL 2” or “SPEED”.

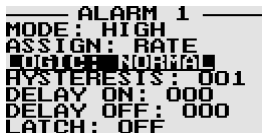

Select the alarm logic. The alarm can be set to “NORMAL” or “INVERT”.



Enter the alarm hysteresis value. The hysteresis value is normally used to prevent an alarm being activated and deactivated when a noisy measurement dithers around the set point value.

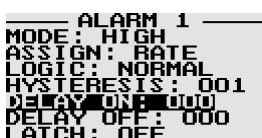

Enter the alarm on delay value in seconds that the alarm condition must persist before the alarm is activated.

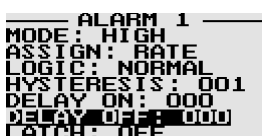

Enter the alarm off delay value in seconds that the alarm condition must persist before the alarm is de-activated.



```

ALARM 1
MODE: HIGH
ASSIGN: RATE
LOGIC: NORMAL
HYSTERESIS: 001
DELAY ON: 000
DELAY OFF: 000
LATCH: OFF

```

The alarm can be set to remain activated even if the alarm condition has been removed. When the alarm condition has gone then the alarm latch can be reset by either a digital input or via the front alarm latch reset push button.



Back to the start of the alarm configuration menu

If the “DEV” alarm mode is selected.

```

ALARM 1
ASSIGN: RATE
LOGIC: NORMAL
HYSTERESIS: 001
DELAY ON: 000
DELAY OFF: 000
LATCH: OFF
DEV LOW: 0100

```

Enter the deviation low value. The low value of the band is the set point minus the deviation low value. This menu option is only shown if the alarm mode is set to deviation.



```

ALARM 1
LOGIC: NORMAL
HYSTERESIS: 001
DELAY ON: 000
DELAY OFF: 000
LATCH: OFF
DEV LOW: 0100
DEV HIGH: 0100

```

Enter the deviation high value. The high value of the band is the set point plus the deviation high value. This menu option is only shown if the alarm mode is set to deviation.

If the “PULSE TOT1” or “PULSE TOT2” alarm mode is selected.

```

ALARM 1
MODE: PULSE TOT1
PULSE LENGTH: 500

```

```

ALARM 1
MODE: PULSE TOT2
PULSE LENGTH: 500

```



```

ALARM 1
MODE: PULSE TOT1
PULSE LENGTH: 500

```

Enter the pulse width in milliseconds of the output pulse.

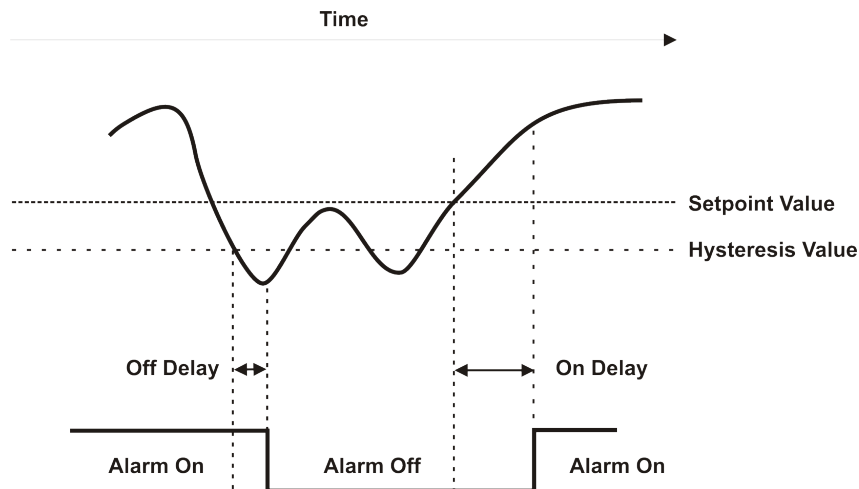

The above diagram illustrates the use of a high alarm with hysteresis and on/off delay.

5.4 Analog Out Configuration Menu

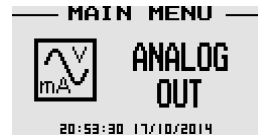

This menu configures the analog output parameters.

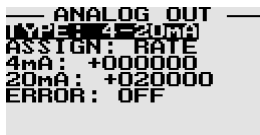

Select the analog output type. The analog output type can be selected from “OFF”, “0-20mA”, “4-20mA” or “0-10V”.

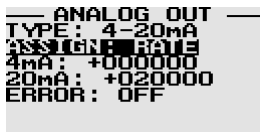

Select the source for the analog retransmission. The source can be selected from the “WEIGHT”, “RATE”, “TOTAL 1”, “TOTAL 2” or “SPEED”.

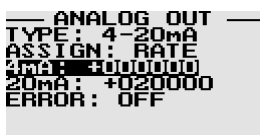

Enter the display value that corresponds to the selected analog output low value. E.G. 0.000 display counts = 4mA. (4-20mA analog output type shown).

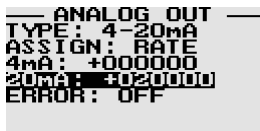

Enter the display value that corresponds to the selected analog output high value. E.G. 20.000 display counts = 20mA. (4-20mA analog output type shown).

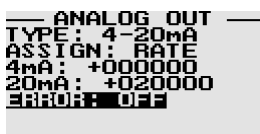

Enter what must happen to the analog output when an error occurs with the measured weight. eg. Over-range, Under-Range etc. The analog error can be set to:

- “OFF”: The analog error feature is disabled.
- “OUT LOW”: The analog output will go to the minimum value when an error occurs.
- “OUT HIGH”: The analog output will go to the maximum value when an error occurs.

5.5 Communications Configuration Menu



This menu configures the RS232 and RS485 serial port parameters.

The LT1320 has 3 built in communication protocols:

- 1) MODBUS™ RTU
- 2) MODBUS™ ASCII
- 3) A simple serial ASCII protocol for interfacing to large displays and serial printers.

Please see below for the LT1320 MODBUS registers.



Enter the communication address of the instrument. If more than one instrument is connected via a multidrop network then the address of each instrument must be unique. A unique address allows commands to be sent to an individual instrument as well as it also prevents all the instruments on the bus replying simultaneously.



The ASCII out protocol address range is 0 to 255. The Modbus address range is 001 to 247.

RS232 Communications setup menu.



RS485 Communications setup menu.

The RS232 Communications setup menu is shown below. The setup for the RS485 communications setup is identical.

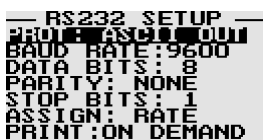

Select the communication protocol. The communication protocol can be set to:

- “ASCII OUT”: A simple ASCII protocol to interface to serial printers and large displays. Please see the format of the ASCII out protocol in section 5.5.1
- “MODBUS RTU”: Modbus RTU protocol
- “MODBUS ASC”: Modbus ASCII protocol.

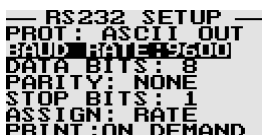

Select the communication baud rate. The baud rate can be selected from “1200”, “2400”, “4800”, “9600”, “19200”, “38400”, “57600” and “115200” baud.



```

-- RS232 SETUP --
PROT: ASCII OUT
BAUD RATE: 9600
DATA BITS: 8
PARITY: NONE
STOP BITS: 1
ASSIGN: RATE
PRINT: ON DEMAND
    
```

Select the communication data bits. "7" or "8" data bits can be selected.



```

-- RS232 SETUP --
PROT: ASCII OUT
BAUD RATE: 9600
DATA BITS: 8
PARITY: NONE
STOP BITS: 1
ASSIGN: RATE
PRINT: ON DEMAND
    
```

Select the communication parity bit. "NONE", "ODD" or "EVEN" parity can be selected.



```

-- RS232 SETUP --
PROT: ASCII OUT
BAUD RATE: 9600
DATA BITS: 8
PARITY: NONE
STOP BITS: 1
ASSIGN: RATE
PRINT: ON DEMAND
    
```

Select the communication stop bit. "1" or "2" stop bits can be selected.



```

-- RS232 SETUP --
PROT: ASCII OUT
BAUD RATE: 9600
DATA BITS: 8
PARITY: NONE
STOP BITS: 1
ASSIGN: RATE
PRINT: ON DEMAND
    
```

Select the source for the communication data. This menu option is only shown if the ASCII Out mode is selected. The communication source can be selected from the "WEIGHT", "RATE", "TOTAL 1", "TOTAL 2", "SPEED", "BELT" or "BELT CSV".

This menu option is only shown if the ASCII Out mode is selected.

```

-- RS232 SETUP --
PROT: ASCII OUT
BAUD RATE: 9600
DATA BITS: 8
PARITY: NONE
STOP BITS: 1
ASSIGN: RATE
PRINT: ON DEMAND
    
```

Select between print "ON DEMAND" or "CONTINUOUS" printing. Print on demand will print the ASCII string by either pressing the front print push button or by using a digital input. Continuous printing will transmit the ASCII string at a rate of 5 times a second.



This menu option is only shown if the ASCII Out mode is selected.

```

-- RS232 SETUP --
BAUD RATE: 9600
DATA BITS: 8
PARITY: NONE
STOP BITS: 1
ASSIGN: RATE
PRINT: ON DEMAND
DATE&TIME: ON
    
```

This menu option enables the date and time to be included in the ASCII output string.



Back to the start of the RS232 or RS485 configuration menu

5.5.1 ASCII Out Protocol

The LT1320 can be output 6 different ASCII strings depending on which string has been assigned to the ASCII out option.

5.5.1.1 ASCII Out – Weight

Example: *123 12:23:45 01/01/2011 +123456.78 kg

<*> = Decimal 42
 <AAA><SPACE> (Unit address. Only transmitted if address > 0)
 <HH:MM:SS><SPACE><DD/MM/YYYY><SPACE> (Optional field if RTC selected) = Time & Date
 <WEIGHT> = 10 digits right justified, leading zero suppression, including decimal point and polarity
 <SPACE> = Decimal 32
 <WEIGHT UNIT> = kg, t, lb, T
 <CR> = Decimal 13
 <LF> = Decimal 10

5.5.1.2 ASCII Out – Belt Rate

Example: *123 12:23:45 01/01/2011 +123456.78 kg/min

<*> = Decimal 42
 <AAA><SPACE> (Unit address. Only transmitted if address > 0)
 <HH:MM:SS><SPACE><DD/MM/YYYY><SPACE> (Optional field if RTC selected) = Time & Date
 <BELT RATE> = 10 digits right justified, leading zero suppression, including decimal point and polarity
 <SPACE> = Decimal 32
 <BELT RATE UNIT> = kg/min, kg/h, t/min, t/h, lb/min, lb/h, T/min, T/h
 <CR> = Decimal 13
 <LF> = Decimal 10

5.5.1.3 ASCII Out – Totaliser 1

Example: *123 12:23:45 01/01/2011 +123456.78 kg

<*> = Decimal 42
 <AAA><SPACE> (Unit address. Only transmitted if address > 0)
 <HH:MM:SS><SPACE><DD/MM/YYYY><SPACE> (Optional field if RTC selected) = Time & Date
 <TOTALISER 1> = 10 digits right justified, leading zero suppression, including decimal point and polarity
 <SPACE> = Decimal 32
 <TOTALISER 1 UNIT> = kg, t, lb, T
 <CR> = Decimal 13
 <LF> = Decimal 10

5.5.1.4 ASCII Out – Totaliser 2

Example: *123 12:23:45 01/01/2011 +123456.78 kg

<*> = Decimal 42
 <AAA><SPACE> (Unit address. Only transmitted if address > 0)
 <HH:MM:SS><SPACE><DD/MM/YYYY><SPACE> (Optional field if RTC selected) = Time & Date
 <TOTALISER 2> = 10 digits right justified, leading zero suppression, including decimal point and polarity
 <SPACE> = Decimal 32
 <TOTALISER 2 UNIT> = kg, t, lb, T
 <CR> = Decimal 13
 <LF> = Decimal 10

5.5.1.5 ASCII Out – Belt Speed

Example: *123 12:23:45 01/01/2011 +123456.78 m/min

<*> = Decimal 42
 <AAA><SPACE> (Unit address. Only transmitted if address > 0)
 <HH:MM:SS><SPACE><DD/MM/YYYY><SPACE> (Optional field if RTC selected) = Time & Date
 <BELT SPEED> = 10 digits right justified, leading zero suppression, including decimal point and polarity
 <SPACE> = Decimal 32
 <BELT SPEED UNIT> = m/min
 <CR> = Decimal 13
 <LF> = Decimal 10

5.5.1.6 ASCII Out – Belt Info

Example: *123 12:23:45 01/01/2011 +123456.78 kg, +123456.78 kg/min, +123456.78 kg, +123456.78 kg, 123.45 m/min, +123456.78 kg

<*> = Decimal 42
 <AAA><SPACE> (Unit address. Only transmitted if address > 0)
 <HH:MM:SS><SPACE><DD/MM/YYYY><SPACE> (Optional field if RTC selected) = Time & Date
 <WEIGHT> = 10 digits right justified, leading zero suppression, including decimal point and polarity
 <SPACE> = Decimal 32
 <WEIGHT UNIT>= kg, t, lb, T
 <SPACE> = Decimal 32
 <BELT RATE> = 10 digits right justified, leading zero suppression, including decimal point and polarity
 <SPACE> = Decimal 32
 <BELT RATE UNIT>= kg/min, kg/h, t/min, t/h, lb/min, lb/h, T/min, T/h
 <SPACE> = Decimal 32
 <TOTALISER 1> = 10 digits right justified, leading zero suppression, including decimal point and polarity
 <SPACE> = Decimal 32
 <TOTALISER 1 UNIT>= kg, t, lb, T
 <SPACE> = Decimal 32
 <TOTALISER 2> = 10 digits right justified, leading zero suppression, including decimal point and polarity
 <SPACE> = Decimal 32
 <TOTALISER 2 UNIT>= kg, t, lb, T
 <SPACE> = Decimal 32
 <BELT SPEED> = 10 digits right justified, leading zero suppression, including decimal point and polarity
 <SPACE> = Decimal 32
 <BELT SPEED UNIT>= m/min
 <SPACE> = Decimal 32
 <TARE VALUE> = 10 digits right justified, leading zero suppression, including decimal point and polarity
 <SPACE> = Decimal 32
 <WEIGHT UNIT>= kg, t, lb, T
 <CR> = Decimal 13
 <LF> = Decimal 10

5.5.1.7 ASCII Out – Belt Info (CSV format)

Example: 123,12:23:45,01/01/2011,+123456.78,kg,+123456.78,kg/min,+123456.78,kg,+123456.78,kg,123.45,m/min,+123456.78,kg

<AAA> = Unit address
 <HH:MM:SS> = (Optional field if RTC selected) Time
 <DD/MM/YYYY> = (Optional field if RTC selected) Date
 <WEIGHT> 10 digits right justified, leading zero suppression, including decimal point and polarity
 <WEIGHT UNIT> = kg, t, lb, T
 <BELT RATE> = 10 digits right justified, leading zero suppression, including decimal point and polarity
 <BELT RATE UNIT> = kg/min, kg/h, t/min, t/h, lb/min, lb/h, T/min, T/h
 <TOTALISER 1> = 10 digits right justified, leading zero suppression, including decimal point and polarity
 <TOTALISER 1 UNIT> = kg, t, lb, T

<TOTALISER 2> = 10 digits right justified, leading zero suppression, including decimal point and polarity>
 <TOTALISER 2 UNIT> = kg, t, lb, T
 <BELT SPEED> = Speed 10 digits right justified, leading zero suppression, including decimal point and polarity>
 <BELT SPEED UNIT> = m/min
 <TARE VALUE> 10 digits right justified, leading zero suppression, including decimal point and polarity
 <WEIGHT UNIT> = kg, t, lb, T
 <CR> = Decimal 13
 <LF> = Decimal 10

5.5.2 The Modbus Protocol

The LT series instruments modbus implementation is based on the following documents:

“MODBUS over Serial Line Specification and Implementation Guide V1.02” from Modbus-IDA.ORG.

And

“MODBUS Application Protocol Specification V1.1b” from Modbus-IDA.ORG.

Details of the Modbus protocol is described in these documents and is available for free download from the following website URLs:

http://modbus-ida.org/docs/Modbus_over_serial_line_V1_02.pdf

<http://www.infiniteq.co.za/manuals.aspx>

5.5.3 Modbus Commands

The LT series of instruments supports the following Modbus commands:

FC03 (0x03) – Read Holding Registers

FC05 (0x05) – Write Single Coil

FC06 (0x06) – Write Single Holding Register

Note: Broadcast read commands are ignored by the indicator, only broadcast write commands are processed.

Supported Modbus Error Messages:

Error Code	Error Description
0x01	Illegal function code
0x02	Illegal register address
0x03	Illegal data value or data length

5.5.4 Modbus Register Addresses

Read Holding Register (FC03), Write Single Holding Register (FC06):

Referenced to 4XXXX.

Address	Data Type	Operation	Description
0	32 bit unsigned	R	Serial Number High Word
1	32 bit unsigned	R	Serial Number Low Word
2	8 bit unsigned	R	Model Number
3	16 bit unsigned	R	Firmware Version
50	32 bit signed	R/W	Alarm 1 Setpoint High Word
51	32 bit signed	R/W	Alarm 1 Setpoint Low Word
52	8 bit unsigned	R/W	Alarm 1 Assignment 0: Weight 1: Rate 2: Totaliser 1 3: Totaliser 2 4: Speed
53	8 bit unsigned	R/W	Alarm 1 Mode 0: Off 1: Low 2: High 3: Deviation 4: Pulse output Totaliser 1 5: Pulse output Totaliser 2
54	8 bit unsigned	R/W	Alarm 1 logic 0: Normal 1: Inverted
55	16 bit unsigned	R/W	Alarm 1 Hysteresis
56	16 bit unsigned	R/W	Alarm 1 Deviation low
57	16 bit unsigned	R/W	Alarm 1 Deviation High
58	16 bit unsigned	R/W	Alarm 1 On Delay
59	16 bit unsigned	R/W	Alarm 1 Off Delay
60	8 bit unsigned	R/W	Alarm 1 Latch 0: Off 1: On
70	32 bit signed	R/W	Alarm 2 Setpoint High Word
71	32 bit signed	R/W	Alarm 2 Setpoint Low Word
72	8 bit unsigned	R/W	Alarm 2 Assignment 0: Weight 1: Rate 2: Totaliser 1 3: Totaliser 2 4: Speed
73	8 bit unsigned	R/W	Alarm 2 Mode

			0: Off 1: Low 2: High 3: Deviation 4: Pulse output Totaliser 1 5: Pulse output Totaliser 2
74	8 bit unsigned	R/W	Alarm 2 logic 0: Normal 1: Inverted
75		R/W	Alarm 2 Hysteresis
76	16 bit unsigned	R/W	Alarm 2 On Delay
77	16 bit unsigned	R/W	Alarm 2 Deviation low
78	16 bit unsigned	R/W	Alarm 2 Deviation High
79	16 bit unsigned	R/W	Alarm 2 Off Delay
80	8 bit unsigned	R/W	Alarm 2 Latch 0: Off 1: On
90	32 bit signed	R/W	Alarm 3 Setpoint High Word
91	32 bit signed	R/W	Alarm 3 Setpoint Low Word
92	8 bit unsigned	R/W	Alarm 3 Assignment 0: Weight 1: Rate 2: Totaliser 1 3: Totaliser 2 4: Speed
93	8 bit unsigned	R/W	Alarm 3 Mode 0: Off 1: Low 2: High 3: Deviation 4: Pulse output Totaliser 1 5: Pulse output Totaliser 2
94	8 bit unsigned	R/W	Alarm 3 logic 0: Normal 1: Inverted
95	16 bit unsigned	R/W	Alarm 3 Hysteresis
96	16 bit unsigned	R/W	Alarm 3 Deviation low
97	16 bit unsigned	R/W	Alarm 3 Deviation High
98	16 bit unsigned	R/W	Alarm 3 On Delay
99	16 bit unsigned	R/W	Alarm 3 Off Delay
100	8 bit unsigned	R/W	Alarm 3 Latch 0: Off 1: On
110	32 bit signed	R/W	Alarm 4 Setpoint High Word
111	32 bit signed	R/W	Alarm 4 Setpoint Low Word
112	8 bit unsigned	R/W	Alarm 4 Assignment 0: Weight 1: Rate

			2: Totaliser 1 3: Totaliser 2 4: Speed
113	8 bit unsigned	R/W	Alarm 4 Mode 0: Off 1: Low 2: High 3: Deviation 4: Pulse output Totaliser 1 5: Pulse output Totaliser 2
114	8 bit unsigned	R/W	Alarm 4 logic 0: Normal 1: Inverted
115	16 bit unsigned	R/W	Alarm 4 Hysteresis
116	16 bit unsigned	R/W	Alarm 4 Deviation low
117	16 bit unsigned	R/W	Alarm 4 Deviation High
118	16 bit unsigned	R/W	Alarm 4 On Delay
119	16 bit unsigned	R/W	Alarm 4 Off Delay
120	8 bit unsigned	R/W	Alarm 4 Latch 0: Off 1: On
130	8 bit unsigned	R/W	Analog Out Assignment 0: Weight 1: Rate 2: Totaliser 1 3: Totaliser 2 4: Speed
131	8 bit unsigned	R/W	Analog Out Type 0: 0 to 20mA 1: 4 to 20mA 2: 0 to 10V 3: Off
132	16 bit unsigned	R/W	Analog Out Low Value High Word
133	16 bit unsigned	R/W	Analog Out Low Value Low Word
134	16 bit unsigned	R/W	Analog Out High Value High Word
135	16 bit unsigned	R/W	Analog Out High Value Low Word
136	8 bit unsigned	R/W	Analog Out Error 0: Off 1: Analog Low 2: Analog High
140	8 bit unsigned	R/W	Com Address
141	8 bit unsigned	R/W	COM 1 (RS232) Protocol 0: ASCII Out 1: ASCII In 2: Modbus RTU 3: Modbus ASCII
142	8 bit unsigned	R/W	COM 1 (RS232) ASCII Out Assignment 0: Weight 1: Rate

			2: Totaliser 1 3: Totaliser 2 4: Speed 5: Belt
143	8 bit unsigned	R/W	COM 1 (RS232) ASCII Out Mode 0: On Demand 1: Continuous
144	8 bit unsigned	R/W	COM 1 (RS232) ASCII Out RTC 0: Off 1: On
145	8 bit unsigned	R/W	COM 1 (RS232) Baud 0: 1200 1: 2400 2: 4800 3: 9600 4: 19200 5: 38400 6: 57600 7: 115200
146	8 bit unsigned	R/W	COM 1 (RS232) Data Bits 0: 7 Bits 1: 8 Bits
147	8 bit unsigned	R/W	COM 1 (RS232) Parity 0: None 1: Even 2: Odd
148	8 bit unsigned	R/W	COM 1 (RS232) Stop bits 0: 1 Stop Bit 1: 2 Stop Bits
160	8 bit unsigned	R/W	COM 2 (RS485) Protocol 0: ASCII Out 1: ASCII In 2: Modbus RTU 3: Modbus ASCII
161	8 bit unsigned	R/W	COM 2 (RS485) ASCII Out Assignment 0: Weight 1: Rate 2: Totaliser 1 3: Totaliser 2 4: Speed 5: Belt
162	8 bit unsigned	R/W	COM 2 (RS485) ASCII Out Mode 0: On Demand 1: Continuous
163	8 bit unsigned	R/W	COM 2 (RS485) ASCII Out RTC 0: Off 1: On
164	8 bit unsigned	R/W	COM 2 (RS485) Baud 0: 1200 1: 2400 2: 4800 3: 9600 4: 19200 5: 38400

			6: 57600 7: 115200
165	8 bit unsigned	R/W	COM 2 (RS485) Data Bits 0: 7 Bits 1: 8 Bits
166	8 bit unsigned	R/W	COM 2 (RS485) Parity 0: None 1: Even 2: Odd
167	8 bit unsigned	R/W	COM 2 (RS485) Stop bits 0: 1 Stop Bit 1: 2 Stop Bits
180	8 bit unsigned	R/W	Rate Key Enable 0: Off 1: On
181	8 bit unsigned	R/W	Total Key Enable 0: Off 1: On
182	8 bit unsigned	R/W	Print Key Enable 0: Off 1: On
183	8 bit unsigned	R/W	Belt tare Key Enable 0: Off 1: On
184	8 bit unsigned	R/W	Alarm Latch Key Enable 0: Off 1: On
190	8 bit unsigned	R/W	Digital Input 1 Assignment 0: Off 1: Min/Max value reset 2: Alarm latch reset 3: Rate/Total toggle 4: Belt tare 5: Print 6: Totaliser 1 reset 7: Totaliser 2 reset
191	8 bit unsigned	R/W	Digital Input 2 Assignment 0: Off 1: Min/Max value reset 2: Alarm latch reset 3: Rate/Total toggle 4: Belt tare 5: Print 6: Totaliser 1 reset 7: Totaliser 2 reset
192	8 bit unsigned	R/W	Digital Input 3 Assignment 0: Off 1: Min/Max value reset 2: Alarm latch reset 3: Rate/Total toggle 4: Belt tare 5: Print 6: Totaliser 1 reset

			7: Totaliser 2 reset
200	8 bit unsigned	R/W	Code Level 0: Only Alarms Setpoints not locked 1: Full Lockout
201	16 bit unsigned	R/W	Password
202	16 bit unsigned	R/W	Set RTC Date Years
203	8 bit unsigned	R/W	Set RTC Date Months
204	8 bit unsigned	R/W	Set RTC Date Days
205	8 bit unsigned	R/W	Set RTC Time Hours
206	8 bit unsigned	R/W	Set RTC Time Minutes
207	8 bit unsigned	R/W	Set RTC Time Seconds
300	8 bit unsigned	R/W	Lineariser Enable
301	8 bit unsigned	R/W	Lineariser Points
302	32 bit signed	R/W	Lineariser Real Point 1 High Word
303	32 bit signed	R/W	Lineariser Real Point 1 Low Word
304	32 bit signed	R/W	Lineariser Real Point 2 High Word
305	32 bit signed	R/W	Lineariser Real Point 2 Low Word
306	32 bit signed	R/W	Lineariser Real Point 3 High Word
307	32 bit signed	R/W	Lineariser Real Point 3 Low Word
308	32 bit signed	R/W	Lineariser Real Point 4 High Word
309	32 bit signed	R/W	Lineariser Real Point 4 Low Word
310	32 bit signed	R/W	Lineariser Real Point 5 High Word
311	32 bit signed	R/W	Lineariser Real Point 5 Low Word
312	32 bit signed	R/W	Lineariser Real Point 6 High Word
313	32 bit signed	R/W	Lineariser Real Point 6 Low Word
314	32 bit signed	R/W	Lineariser Real Point 7 High Word
315	32 bit signed	R/W	Lineariser Real Point 7 Low Word
316	32 bit signed	R/W	Lineariser Real Point 8 High Word
317	32 bit signed	R/W	Lineariser Real Point 8 Low Word
318	32 bit signed	R/W	Lineariser Real Point 9 High Word
319	32 bit signed	R/W	Lineariser Real Point 9 Low Word
320	32 bit signed	R/W	Lineariser Real Point 10 High Word
321	32 bit signed	R/W	Lineariser Real Point 10 Low Word
322	32 bit signed	R/W	Lineariser Real Point 11 High Word
323	32 bit signed	R/W	Lineariser Real Point 11 Low Word
324	32 bit signed	R/W	Lineariser Real Point 12 High Word
325	32 bit signed	R/W	Lineariser Real Point 12 Low Word
326	32 bit signed	R/W	Lineariser Real Point 13 High Word
327	32 bit signed	R/W	Lineariser Real Point 13 Low Word
328	32 bit signed	R/W	Lineariser Real Point 14 High Word

329	32 bit signed	R/W	Lineariser Real Point 14 Low Word
330	32 bit signed	R/W	Lineariser Real Point 15 High Word
331	32 bit signed	R/W	Lineariser Real Point 15 Low Word
332	32 bit signed	R/W	Lineariser Real Point 16 High Word
333	32 bit signed	R/W	Lineariser Real Point 16 Low Word
334	32 bit signed	R/W	Lineariser Display Point 1 High Word
335	32 bit signed	R/W	Lineariser Display Point 1 High Word
336	32 bit signed	R/W	Lineariser Display Point 2 High Word
337	32 bit signed	R/W	Lineariser Display Point 2 High Word
338	32 bit signed	R/W	Lineariser Display Point 3 High Word
339	32 bit signed	R/W	Lineariser Display Point 3 High Word
340	32 bit signed	R/W	Lineariser Display Point 4 High Word
341	32 bit signed	R/W	Lineariser Display Point 4 High Word
342	32 bit signed	R/W	Lineariser Display Point 5 High Word
343	32 bit signed	R/W	Lineariser Display Point 5 High Word
344	32 bit signed	R/W	Lineariser Display Point 6 High Word
345	32 bit signed	R/W	Lineariser Display Point 6 High Word
346	32 bit signed	R/W	Lineariser Display Point 7 High Word
347	32 bit signed	R/W	Lineariser Display Point 7 High Word
348	32 bit signed	R/W	Lineariser Display Point 8 High Word
349	32 bit signed	R/W	Lineariser Display Point 8 High Word
350	32 bit signed	R/W	Lineariser Display Point 9 High Word
351	32 bit signed	R/W	Lineariser Display Point 9 High Word
352	32 bit signed	R/W	Lineariser Display Point 10 High Word
353	32 bit signed	R/W	Lineariser Display Point 10 High Word
354	32 bit signed	R/W	Lineariser Display Point 11 High Word
355	32 bit signed	R/W	Lineariser Display Point 11 High Word
356	32 bit signed	R/W	Lineariser Display Point 12 High Word
357	32 bit signed	R/W	Lineariser Display Point 12 High Word
358	32 bit signed	R/W	Lineariser Display Point 13 High Word
359	32 bit signed	R/W	Lineariser Display Point 13 High Word
360	32 bit signed	R/W	Lineariser Display Point 14 High Word
361	32 bit signed	R/W	Lineariser Display Point 14 High Word
362	32 bit signed	R/W	Lineariser Display Point 15 High Word
363	32 bit signed	R/W	Lineariser Display Point 15 High Word
364	32 bit signed	R/W	Lineariser Display Point 16 High Word
365	32 bit signed	R/W	Lineariser Display Point 16 High Word
400	8 bit unsigned	R/W	Load Cell Unit
401	8 bit unsigned	R/W	Load Cell Decimal Point
402	8 bit unsigned	R/W	Load Cell Display Step Increment

403	8 bit unsigned	R/W	Load Cell Filter Time
404	8 bit unsigned	R/W	Load Cell Zero Band
405	32 bit signed	R/W	Load Cell Low Display High Word
406	32 bit signed	R/W	Load Cell Low Display Low Word
407	32 bit signed	R/W	Load Cell High Display High Word
408	32 bit signed	R/W	Load Cell High Display Low Word
409	32 bit signed	R/W	Load Cell Low Display mV/V High Word
410	32 bit signed	R/W	Load Cell Low Display mV/V Low Word
411	32 bit signed	R/W	Load Cell High Display mV/V High Word
412	32 bit signed	R/W	Load Cell High Display mV/V Low Word
413	16 bit unsigned	R/W	Load Cell Zero Band
414	8 bit unsigned	R/W	Load Cell Auto Zero Enable
415	16 bit unsigned	R/W	Load Cell Auto Zero Delay
418	32 bit signed	R/W	Load Cell Tare Value High Word
419	32 bit signed	R/W	Load Cell Tare Value Low Word
420	32 bit signed	R	Load Cell Gross Value High Word
421	32 bit signed	R	Load Cell Gross Value Low Word
422	32 bit signed	R	Load Cell Net Value High Word
423	32 bit signed	R	Load Cell Net Value Low Word
426	32 bit signed	R	Load Cell Maximum Value High Word
427	32 bit signed	R	Load Cell Maximum Value Low Word
450	8 bit unsigned	R/W	Averaging sample rate
451	8 bit unsigned	R/W	Rate unit
452	8 bit unsigned	R/W	Totaliser 1 unit
453	8 bit unsigned	R/W	Totaliser 2 unit
454	32 bit signed	R/W	Belt weigh length High Word
455	32 bit signed	R/W	Belt weigh length Low Word
456	32 bit signed	R/W	Belt dead band High Word
457	32 bit signed	R/W	Belt dead band Low Word
458	32 bit signed	R/W	Rate correction factor High Word
459	32 bit signed	R/W	Rate correction factor Low Word
460	8 bit unsigned	R/W	Belt speed
461	32 bit signed	R/W	Belt speed user value High Word
462	32 bit signed	R/W	Belt speed user value Low Word
463	32 bit signed	R/W	Pulley diameter High Word
464	32 bit signed	R/W	Pulley diameter Low Word
465	32 bit signed	R/W	Encoder Pulses/Rev High Word
466	32 bit signed	R/W	Encoder Pulses/Rev Low Word
467	8 bit unsigned	R/W	Frequency measurement type
468	8 bit unsigned	R/W	Frequency pulse gate time

469	32 bit signed	R	Belt rate value High Word
470	32 bit signed	R	Belt rate value Low Word
471	32 bit signed	R	Belt rate max value High Word
472	32 bit signed	R	Belt rate max value Low Word
473	32 bit signed	R	Belt speed value High Word
474	32 bit signed	R	Belt speed value Low Word
475	32 bit signed	R	Belt speed max value High Word
476	32 bit signed	R	Belt speed max value Low Word
477	32 bit signed	R	Belt frequency value High Word
478	32 bit signed	R	Belt frequency value Low Word
479	32 bit signed	R	Belt RPM value High Word
480	32 bit signed	R	Belt RPM value Low Word
481	32 bit signed	R	Totaliser 1 value High Word
482	32 bit signed	R	Totaliser 1 value Low Word
483	32 bit signed	R	Totaliser 2 value High Word
484	32 bit signed	R	Totaliser 2 value Low Word

FC05: Write Single Coil

Referenced to 0XXXX. A value of 0xFF00 for the data will execute the function. An Echo of the original message will be returned.

Address	Action Command
0	Instrument Reset
1	Load Default Settings
2	Latched Alarm Reset
3	Min/Max Value Reset
4	Activate External Input 1
5	Activate External Input 2
6	Activate External Input 3
7	Set RTC
8	Reset Totaliser 1
9	Reset Totaliser 2
10	Display Rate
11	Display Totaliser 1
12	Belt Tare

5.6 Function Key Configuration Menu



This menu configures the front panel function key push buttons.

```
- FUNCTION KEYS -
RATE: ENABLED
TOTAL: ENABLED
PRINT: ENABLED
TARE: ENABLED
LAT RST: ENABLED
```

This menu option will enable the display rate push button. If enabled, this function key will allow the user to display the belt rate value on the LED display.

```
- FUNCTION KEYS -
RATE: ENABLED
TOTAL: ENABLED
PRINT: ENABLED
TARE: ENABLED
LAT RST: ENABLED
```

This menu option will enable the display totaliser 1 push button. If enabled, this function key will allow the user to display the totaliser 1 value on the LED display.

```
- FUNCTION KEYS -
RATE: ENABLED
TOTAL: ENABLED
PRINT: ENABLED
TARE: ENABLED
LAT RST: ENABLED
```

This menu option will enable the print push button. If enabled, this function key allows the user to print the assigned value via the RS232 or the RS485 interface. The print LED will briefly illuminate when the print push button is pressed. The print button will only work if either the RS232 or RS485 ASCII Out mode is selected.

```
- FUNCTION KEYS -
RATE: ENABLED
TOTAL: ENABLED
PRINT: ENABLED
TARE: ENABLED
LAT RST: ENABLED
```

This menu option will enable the belt tare push button. If enabled, this function key will allow the user to tare the belt weigher.

```
- FUNCTION KEYS -
RATE: ENABLED
TOTAL: ENABLED
PRINT: ENABLED
TARE: ENABLED
LAT RST: ENABLED
```

This function will enable the alarm latch push button. If enabled, this function key will reset any of the latched alarms when the alarm condition has been removed. This menu option is only displayed if any of the alarm latch functions have been enabled.

5.7 Digital Input Configuration Menu



This menu configures the three digital inputs. The digital inputs can be configured for specific functions as listed below.



The digital input is disabled.

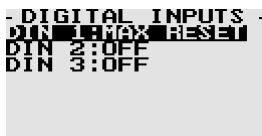

The digital input will reset the maximum recorder rate, speed and weight values to the current values.



The digital input will reset any of the latched alarms when the alarm condition has been removed. This menu option is only displayed if any of the alarm latch functions have been enabled.



The digital input will toggle the LED display between showing the rate and the totaliser 1 value. The rate LED will illuminate to indicate that the LED display is showing the rate value alternatively the total LED will illuminate to indicate that the display is showing the totaliser 1 value.

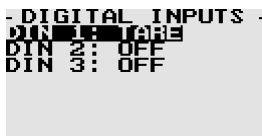

The digital input will start the belt tare function.

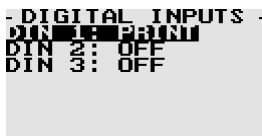

This menu option is only shown if either the RS232 or RS485 ASCII Out mode is selected. This digital input allows the user to print the display value via the RS232 or the RS485 interface. The print LED will briefly illuminate when the digital input is activated.



The digital input will reset the totaliser 1 value to zero.



The digital input will reset the totaliser 2 value to zero.

5.8 Miscellaneous Configuration Menu

This menu configures the miscellaneous functions of the instrument.



```
- MISCELLANEOUS -
LCD CONTRAST
BACKLIGHT: ON
SECURITY SETUP
SET DATE&TIME
UNIT INFORMATION
RESET TOTAL 2
ACCESS CODE
```



```
- LCD CONTRAST -
[Progress bar]
USE THE ← → KEYS
TO ADJUST THE
CONTRAST
```

Select this menu option to adjust the LCD display contrast.



```
- MISCELLANEOUS -
LCD CONTRAST
BACKLIGHT: ON
SECURITY SETUP
SET DATE&TIME
UNIT INFORMATION
RESET TOTAL 2
ACCESS CODE
```

Select this menu option to turn the LCD backlight either on or off.



```
- MISCELLANEOUS -
LCD CONTRAST
BACKLIGHT: ON
SECURITY SETUP
SET DATE&TIME
UNIT INFORMATION
RESET TOTAL 2
ACCESS CODE
```



```
- SECURITY SETUP -
LEVEL: 0
CHANGE CODE
MENU LOCK ONLY
```

Select this menu option if you want to password protect the menu system and the alarm setpoints.

- “LEVEL: 0”: Full access, no protection.
- “LEVEL: 1”: Menu lock only. Allow editing of the alarm setpoints.
- “LEVEL: 2”: Full protection. Menu and alarm setpoints are password protected.

```
ENTER CURRENT
CODE
0000
```



```
ENTER NEW
CODE
0000
```



```
CONFIRM NEW
CODE
0000
```



```
MESSAGE
! CODE
CHANGED
```

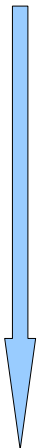

```
ENTER SECURITY
CODE
0000
```

If a password has been set and one of the levels for access control has been selected then the instrument will prompt the user to enter the password. If the code is correct then it will allow the user into the menu system or edit the alarm setpoints otherwise it will return to the normal display mode.

```
- MISCELLANEOUS -
LCD CONTRAST
BACKLIGHT: ON
SECURITY SETUP
SET DATE&TIME
UNIT INFORMATION
RESET TOTAL 2
ACCESS CODE
```



```
- SET DATE&TIME -
YEAR: 2012
MONTH: 07
DAY: 19
HOUR: 22
MINUTE: 05
SECOND: 51
```

This menu option allows the user to set the RTC (Real Time Clock).



```
- MISCELLANEOUS -
LCD CONTRAST
BACKLIGHT: ON
SECURITY SETUP
SET DATE&TIME
UNIT INFORMATION
RESET TOTAL 2
ACCESS CODE
```



```
- INFORMATION -
MODEL: LT1320
FIRMWARE: 1.00
S/N: 0000000
```

This menu option shows the system information.



```
- MISCELLANEOUS -
LCD CONTRAST
BACKLIGHT: ON
SECURITY SETUP
SET DATE&TIME
UNIT INFORMATION
RESET TOTAL 2
ACCESS CODE
```



```
RESET
TOTALISER 2?
[0] YES
```

This menu option allows the user to reset the Totaliser 2 value to zero.

```
- MISCELLENEOUS -
LCD CONTRAST
BACKLIGHT : ON
SECURITY SETUP
SET DATE&TIME
UNIT INFORMATION
RESET TOTAL 2
ADDRESS CODE
```



```
ENTER ACCESS
CODE
00000
```

This menu option allows access to technical functions such as input signal and analog output calibration. These functions are accessed by the factory during the calibration of the instrument. Please consult the factory for more information.



Back to the start of the miscellaneous configuration menu.

6 Error Messages

Display Under Range:



If the display value exceeds the negative display threshold of -199999 then the LED display under range message is shown.

Display Over Range:



If the display value exceeds the positive display threshold of 999999 then the LED display over range message is shown.

Analog Out mA Open Loop Error:



The LCD display will briefly flash the loop error message every 5 seconds to indicate that a mA loop error has occurred. This error message will only be shown if the analog out has been set for any of the mA ranges.

Other Error Messages:



Unit settings CRC error. Load default settings to restore to factory defaults. If the error message still persists then it could possibly be a non-volatile memory failure in which case the instrument will then have to be returned to the factory.



Calibration constants CRC error. The instrument could possibly have a non-volatile memory failure in which case the instrument will then have to be returned to the factory.

MESSAGE
 MAX VALUES
 CRC ERROR

Maximum Values CRC error. The instrument could possibly have a flat battery. Check the internal CR2032 battery voltage and replace if needed.

MESSAGE
 TOTALISERS
 CRC ERROR

Totaliser saving CRC error. The instrument could possibly have a flat battery. Check the internal CR2032 battery voltage and replace if needed.

MESSAGE
 PULSE OUTPUT
 CRC ERROR

Pulse output saving CRC error. The instrument could possibly have a flat battery. Check the internal CR2032 battery voltage and replace if needed.

7 Display Test, Firmware and Model Number

On start up, the instrument will do a LED display test whereby all the segments of the LED display are turned on. It will also display the model number and firmware revision number on the LCD display.



LOADTECH
 LT1320 1.00
 WWW.LOADTECH.CO.ZA

8 Firmware Upgrading

The LT1320 Belt Weigher can be upgraded in the field by connecting the RS232 port to a PC and running the firmware update program. **Note that only the RS232 port can be used to upgrade the firmware.**

Steps to follow to upgrade the firmware:

- 1) Connect the RS232 port on the instrument to the PC RS232 port as described in the table below.
- 2) Run the upgrade program on the PC that matches your instrument.
- 3) Select the correct Com Port and click the “Connect” button.
- 4) Power up the instrument while pressing the  key on the keypad.
- 5) The words “FIRMWARE UPGRADE UTILITY” should be displayed on the instrument LCD display.
- 6) The words “Ready to program” will be displayed in the text area and the “Update Firmware” button will be enabled
- 7) Click the “Update firmware” button and the firmware will begin to be updated.
- 8) The following screen will be displayed if successful.

PC connections:

D9 Female Connector	LT1320
Pin 2	RS232 TXD
Pin 3	RS232 RXD
Pin 5	GND

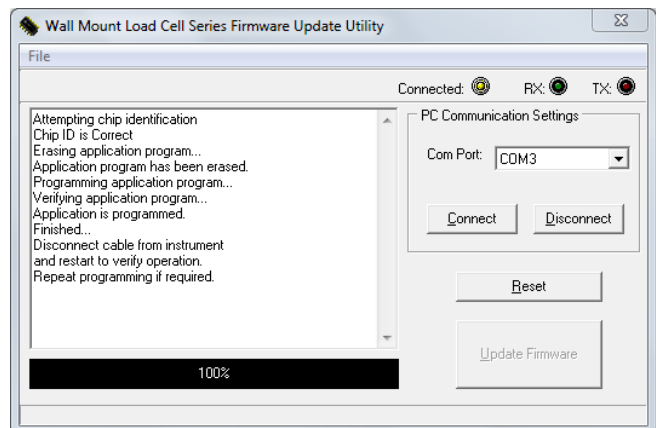

9 Loading Default Settings

Default settings can be loaded by pressing the  key at power up. The words “LOADING DEFAULT SETTINGS” will briefly appear on the LCD display. All settings will be revert back to the factory defaults.

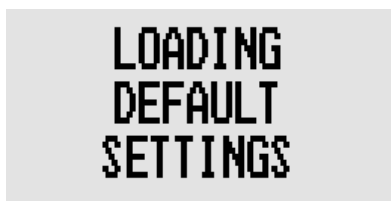

10 Cleaning

The unit should not be cleaned with any abrasive substances. The instrument is very sensitive to certain cleaning materials and should only be cleaned using a clean, damp cloth.

11 Ordering Information

Add option codes to suffix of model number separated by hyphens.

Example:

(LT1320 Belt Weigher indicator with low voltage isolated DC power supply)

LT1320-700

Option part numbers:

- 700 - Low voltage 10-30VDC isolated power supply
- 720 - 1 Solid-state relay
- 721 - 2 Solid-state relays
- 722 - 3 Solid-state relays
- 723 - 4 Solid-state relays
- 731 - 16 Bit Isolated Analog Output (0/4-20mA, 0-10V)
- 762 – 115VAC Inductive load suppressor
- 763 – 230VAC Inductive load suppressor
- 764 – 2A Slow blow replacement fuse
- 765 – R-C Snubber noise and arc suppressor

12 Website

An electronic copy of this manual can be downloaded from www.loadtech.co.za.

13 Notice

Specifications of the products displayed herein are subject to change without notice. Infiniteq cc, or anyone on its behalf, assumes no responsibility or liability for any errors or inaccuracies.

Information contained herein is intended to provide a product description only. No license, express or implied, by estoppel or otherwise, to any intellectual property rights is granted by this document. Except as provided in Infiniteq's terms and conditions of sale for such products, Infiniteq assumes no liability whatsoever, and disclaims any express or implied warranty, relating to sale and/or use of Infiniteq products including liability or warranties relating to fitness for a particular purpose, merchantability, or infringement of any patent, copyright, or other intellectual property right.

The products shown herein are not designed for use in medical, life-saving, or life-sustaining applications. Customers using or selling these products for use in such applications do so at their own risk and agree to fully indemnify Infiniteq for any damages resulting from such improper use or sale.

14 Warranty

This product carries a warranty for a period of one year from date of purchase against faulty workmanship or defective materials, provided there is no evidence that the unit has been mishandled or misused. Warranty is limited to the replacement of faulty components and includes the cost of labor. Shipping costs are for the account of the purchaser.

Note: Product warranty excludes damages caused by unprotected, unsuitable or incorrectly wired electrical supplies and or sensors, and damage caused by inductive loads.

DISTRIBUTED BY: