

# LT1240

## Panel Mount Load Cell Indicator

Operating Manual – English 2.00



14 Segment  
LED Displays

0-10V  
0-20mA  
4-20mA

Analog  
Re-Transmission



4 or 6 Wire  
Load Cells



5VDC  
Excitation



High Resolution  
ADC



High Resolution  
DAC



Modbus™  
Communications



Auto Zero  
Function



Field upgradeable  
Firmware



Scale Motion  
Indication



Advanced  
Digital Filtering



RTC Option



Tare  
Function



4 Alarm  
Setpoints



Gross/Net  
Function



RS232  
&  
RS485

## Introduction

The LT1240 panel mount load cell indicator is a precision digital indicator for load cell and strain gauge applications.

The high bright 6-digit 14 segment LED displays make for easy setup and readability. A simple menu system with built in help hints allows for easy configuration of display and load cell settings. The load cell calibration can be done directly from the load cell calibration certificate or from using known weights / load cell simulator.

A universal mains switch mode power supply (85-264VAC) is provided as standard but an optional low voltage (10-30VDC) isolated power supply or a high voltage (25-70VDC) isolated power supply can be installed.

The LT1240 contains precision front end circuitry for high accuracy and stability. The ratiometric ADC circuitry automatically compensates for temperature drift and excitation voltage variances due to cable loss. The load cell excitation voltage is 5VDC and can interface with both 4 wire and 6 wire load cells. The LT1240 can power up to 6x350Ω load cells.

RS232 communications is supplied as standard with the MODBUS™ RTU and MODBUS™ ASCII protocol. A simple ASCII out protocol is also provided for serial printing and communicating to large displays. A second communication RS485 interface can be added in conjunction with the standard RS232 interface.

The LT1240 also has an analog out or an isolated analog out option to generate a precise 0/4-20mA or 0-10V analog output signal.

The LT1240 also includes advanced features such as auto-zero tracking, user input linearisation, max/min recording, programmable front push buttons, programmable digital inputs, security menu lockout, motion indication, advanced digital filtering, plus many more to provide a all in one precision load cell indicator.

# 1 Features

- High bright 6-digit 14 segment LED displays for easy setup and calibration
- 4 or 6 wire load cell / strain gauge input
- Can power up to 6x350Ω load cells at +5VDC excitation voltage
- High precision 24 bit ratiometric ADC front end circuitry
- -199999 to +999999 display counts
- Easy calibration either from the load cell calibration certificate or by using known weights / load cell simulator
- RS232 communications standard (MODBUS™ RTU/ASCII and an Infiniteq ASCII out protocol)
- Type 4X, NEMA 4X front panel. 96X48 ABS/Polycarbonate enclosure
- Universal mains switch mode power supply (85-264VAC) standard with built in EMI and fuse protection
- 2x Programmable digital inputs (pull up or pull down field jumper selectable)
- 3x Programmable front panel push buttons
- 16 Point lineariser
- Auto-zero tracking function
- Automatic offset calibration
- Tare function
- Gross/net function
- Selectable/adjustable advanced digital filtering
- Motion indication and Net front panel LED status
- Up to 4 front panel LED indicators for alarm set point status (Mechanical or solid-state option required)
- Maximum/Minimum recording
- Built in menu help hints
- Field upgradable firmware via the RS232 interface
- 1 Year Warranty

## Additional hardware options include:

- Up to 4 Mechanical (FORM-C) or solid state (FORM-A) alarm set points
- 16 Bit analog output (0/4-20mA, 0-10V)
- 16 Bit Isolated analog output (0/4-20mA, 0-10V)
- Second communication RS485 interface
- RTC (Real Time clock) option for time and date stamping
- Low voltage 10-30VDC Isolated power supply
- High voltage 25-70VDC Isolated power supply



This instrument is marked with the international hazard symbol. It is important to read this manual before installing or commissioning your panel meter as it contains important information relating to safety and Electromagnetic Compatibility EMC.

**ENSURE THAT ALL POWER IS SWITCHED OFF TO THE INSTRUMENT BEFORE INSTALLING OR DOING MAINTENANCE WORK.**

- **Do not place signal and power supply wiring in the same loom.**
- **Make sure that all anti-static precautions are adhered to when handling the circuit boards.**
- **Use screened cable for all signal inputs and attach to earth at one point only.**
- **Use ferrules with all input connections for greater reliability.**



The instrument may contain a battery for data retention purposes. The battery should be disposed of correctly. Please contact your supplier or local council if in doubt.

## 2 Specifications

<b>General:</b>	
<b>Display</b>	6-Digit, 13.8mm (0.543") 14 segment high brightness red LED
<b>Display range</b>	-199999 to +999999
<b>Display decimal point</b>	0 to 0.00000
<b>Status LEDs</b>	6 LEDs total (SP1 to SP4, Net & Motion)
<b>Digital Inputs</b>	2 Programmable digital inputs Built in hysteresis, filter and input over voltage protection Maximum input voltage <30VDC Input logic is field jumper selectable (Pull up, sinking inputs) - 10kΩ internal resistor to 5V (Pull down, sourcing inputs) – 10kΩ internal resistor to common Active/Non-Active input trigger: <1.9V Non-Active/Active input trigger: >2.3V
<b>Keypad</b>	4 keys total, 3 programmable keys
<b>Memory storage</b>	Non-volatile EEPROM, 100000 write cycles minimum
<b>Warm up time</b>	15 minutes
<b>Power Requirements:</b>	
<b>AC Power Supply</b>	85-264VAC, 50/60Hz or 120-370VDC Isolation: 3000VAC/1min
<b>DC Power Supply, 10-30VDC (Optional)</b>	10-30VDC input Reverse and over voltage protected Isolation: >1000V/1min
<b>DC Power Supply, 20-70VDC (Optional)</b>	25-70VDC input Reverse and over voltage protected Isolation: >1000V/1min
<b>Power Consumption</b>	<10W (Depending on options selected)
<b>Fuse (Built in)</b>	2A Slow Blow (Wickmann 3721200000) RS components part number 226-6599
<b>Environmental:</b>	
<b>Operating temperature</b>	-10°C to 50°C (14°F to 122°F)
<b>Storage temperature</b>	-40°C to 80°C (-40°F to 176°F)
<b>Operating and storage humidity</b>	<85% RH non-condensing
<b>Enclosure:</b>	
<b>Overall Dimensions</b>	96x48x112mm (LxHxD) (3.78x1.89x4.41") (Depth includes connectors)
<b>Mounting</b>	92x45mm (3.62x1.77")
<b>Enclosure Material</b>	Rear ABS plastic, Front Polycarbonate
<b>Front Facia Rating</b>	IP65, with o-ring supplied as standard
<b>Wiring connections</b>	Removable terminal blocks
<b>Input:</b>	
<b>ADC Resolution</b>	24 bit Delta-sigma, Ratiometric
<b>Input range</b>	+/-3.5mV/V
<b>Conversion rate</b>	10 updates/second
<b>Filter</b>	Moving average digital filter with programmable input step detection
<b>Increment size</b>	1, 2, 5, 10, 20, 50, 100, 200
<b>Input Impedance</b>	>100MΩ
<b>CMRR</b>	>-110dB
<b>Linearity</b>	<0.01% of full scale
<b>Accuracy</b>	0.05% of full scale
<b>Calibration method</b>	From the load cell calibration certificate or from using known weights / load cell simulator

<b>Load cell connection</b>	4 or 6 wire connection + shield (Sense included)
<b>Load Cell Excitation:</b>	
<b>Excitation Voltage (Sense included)</b>	+5VDC Fixed
<b>Excitation current</b>	Max. 90mA Up to 6x350Ω load cells or 10x1000Ω load cells
<b>Cable compensation</b>	Ratiometric
<b>Analog Out: (Optional)</b>	
<b>Ranges (Selectable through menu)</b>	0-20mA 4-20mA 0-10V
<b>DAC Resolution</b>	16 Bit
<b>Update rate</b>	10 updates/second
<b>Current output compliance (maximum load)</b>	500Ω (Current is source, not sink)
<b>Voltage output compliance (minimum load)</b>	1kΩ
<b>Current open loop detection</b>	Display flashes "mA.Loop" error message
<b>Linearity</b>	<0.02% of full scale
<b>Accuracy</b>	0.05% of full scale
<b>Isolation (Optional)</b>	1000VDC @ 1mA for 1 minute
<b>Communications:</b>	
<b>Protocol</b>	MODBUS RTU MODBUS ASCII ASCII In (Infiniteq Protocol) ASCII Out (Infiniteq Protocol)
<b>RS232 Communications (Standard)</b>	Baud rate: 1200,2400,4800,9600,19200,38400,57600,115200 Data bits: 7 or 8 bits Parity: Odd, Even or None Stop bits: 1 or 2 stop bits Non isolated
<b>RS485 Communications (Optional)</b>	Baud rate: 1200,2400,4800,9600,19200,38400,57600,115200 Data bits: 7 or 8 bits Parity: Odd, Even or None Stop bits: 1 or 2 stop bits Internal 120Ω field jumper selectable termination resistor Max 32 instruments per line
<b>SetPoints: (Optional, Up to 4 can be fitted)</b>	
<b>Electro-mechanical Relays:</b>	
<b>Contact rating</b>	3A@250VAC or 30VDC (Resistive load)
<b>Type</b>	FORM-C (Change over contact (NO/NC))
<b>Life expectancy</b>	>100K cycles min. at full load rating. External RC snubber extends relay life for operation with inductive loads
<b>Solid-State Relays (SSR):</b>	
<b>Contact rating</b>	120mA@400VAC/DC
<b>Dielectric strength</b>	>1000VAC for 1 minute
<b>Type</b>	FORM-A (Normally open)
<b>RTC (Real Time Clock): (Optional)</b>	
<b>Battery</b>	CR2032
<b>Accuracy</b>	Better then 2 seconds per day (Temperature dependent)

### 3 Installation

#### 3.1 Dimensions & Front panel layout

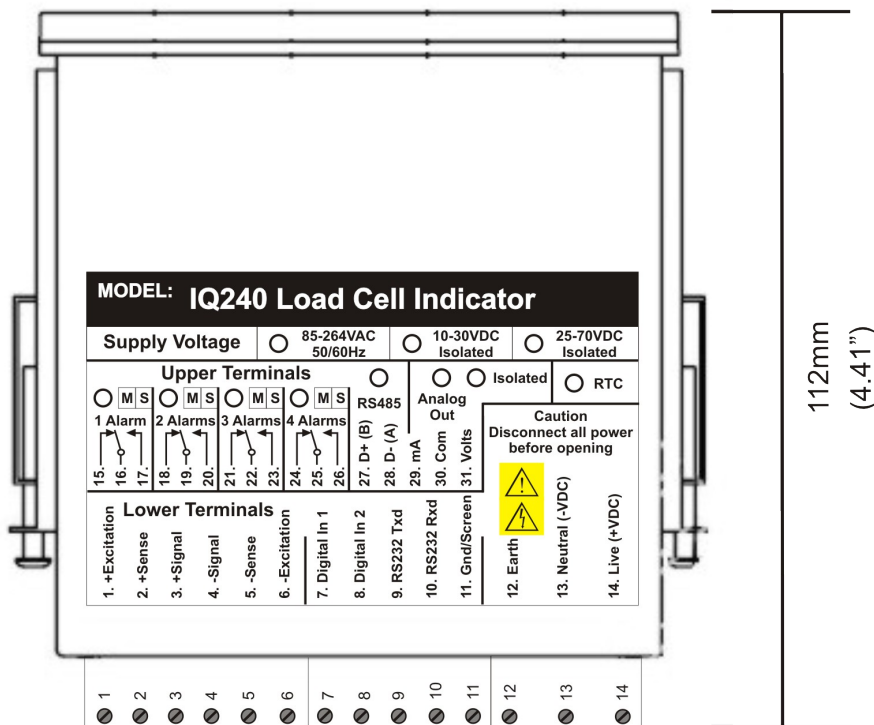
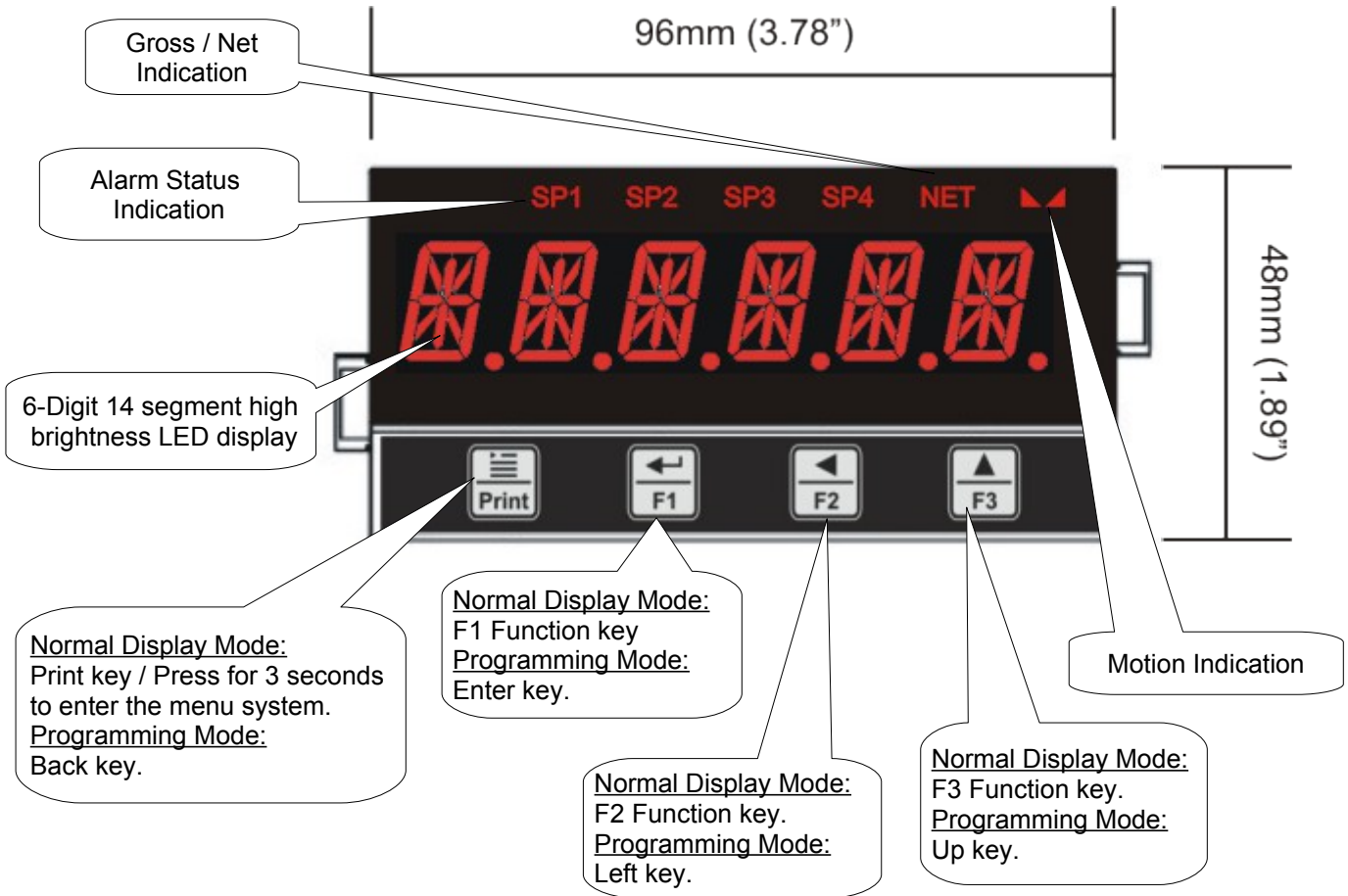

### 3.2 Panel Cutout

A rectangular cutout measuring 92x45mm (3.62"x1.77") must be made in the mounting enclosure. The LT1240 instrument should preferably be mounted in a grounded metal enclosure.

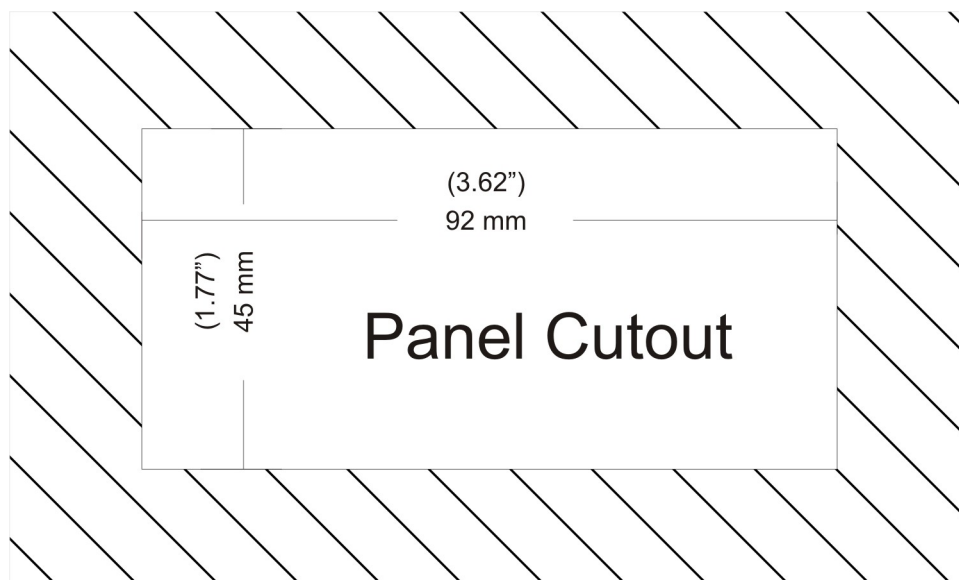

The supplied o-ring must be attached to the front cover to provide sealing between the indicator and the mounting enclosure. The two supplied fastening metal side clips must be attached to either side as in the diagram below. Do not over tighten the screws.

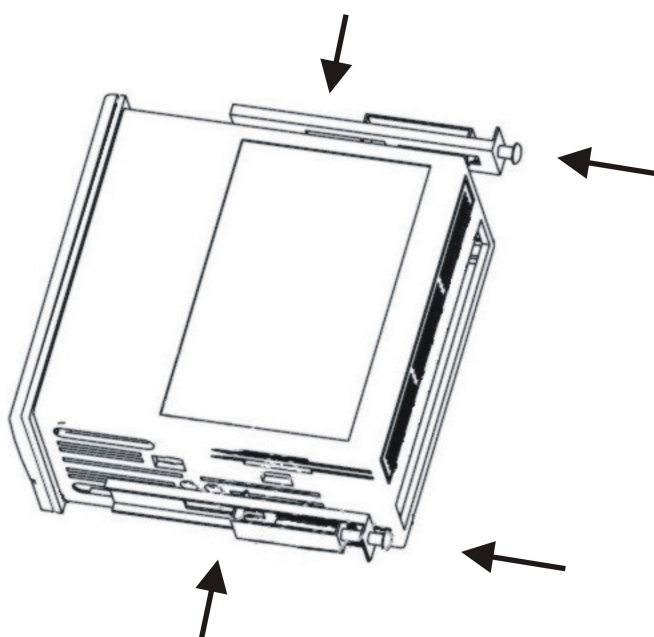

### 3.3 Hardware Connection (Lower Terminals)

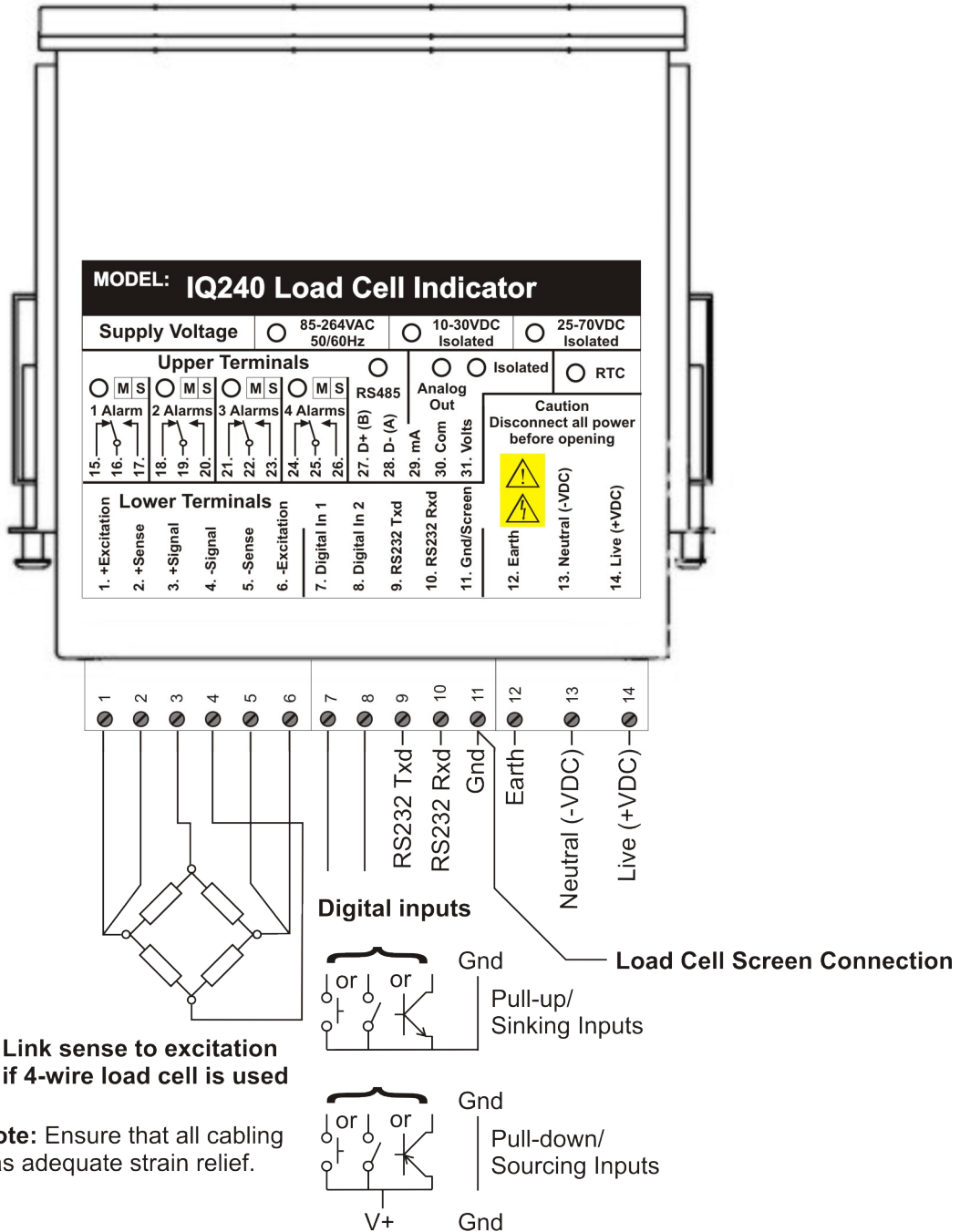



### 3.4 Hardware Connection (Upper Terminals – Option PCB)

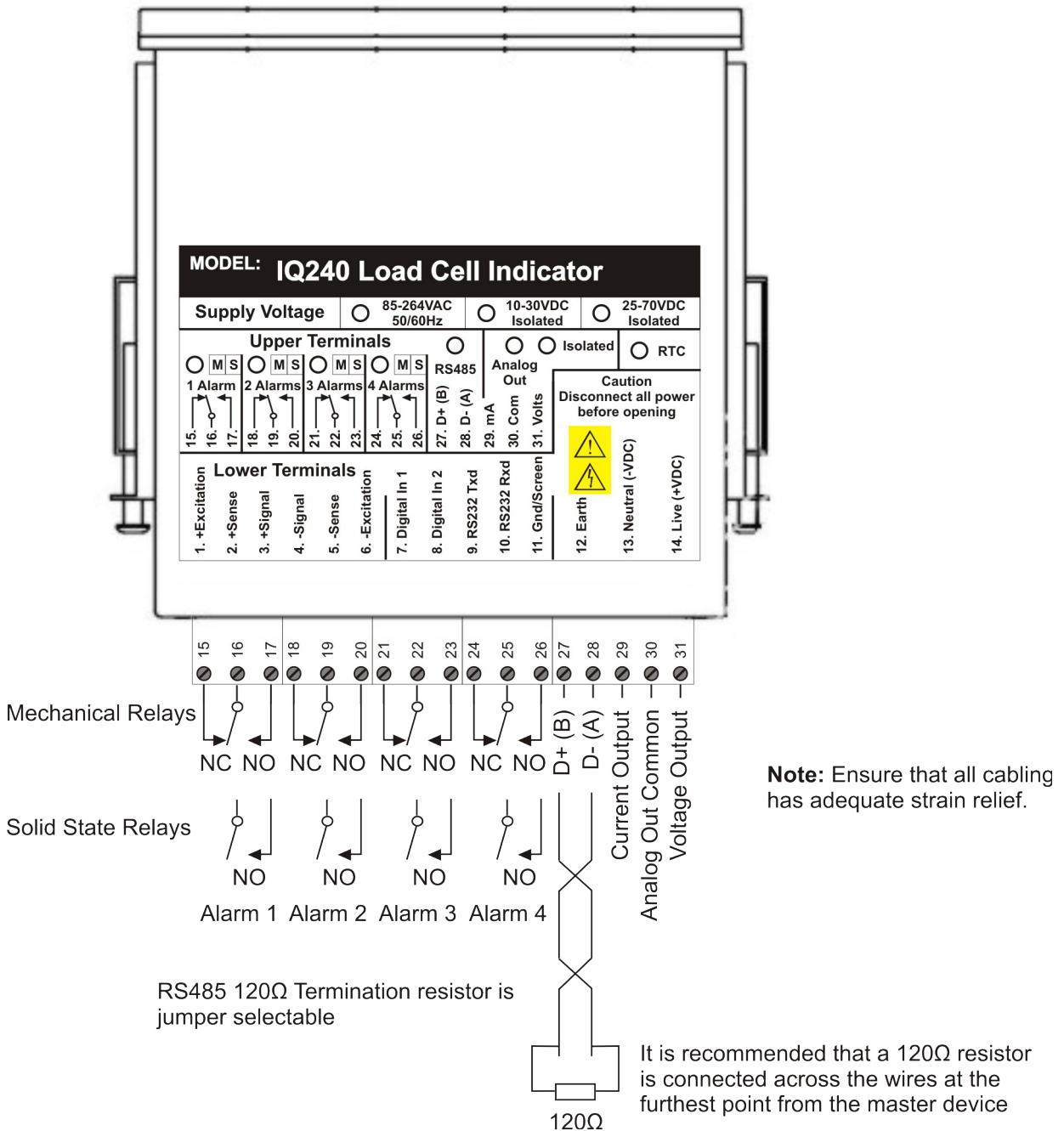

### 3.5 Opening the Unit

**Make sure power and all connectors have been removed before opening the unit.**

To open the unit simply remove all the connectors from the rear and unscrew the 2 or 4 (Depending if an option board has been installed) screws and simply slide out the instrument from the enclosure.

The front transparent face needs to be clipped off from the top and bottom circuit boards in order to add or remove the option circuit board. When reassembling the unit, please make sure that the front push buttons are seated correctly before clipping the front transparent cover onto the circuit boards.

**Make sure full anti-static precautions are adhered to when handling the circuit boards.**

**Do not apply power to the instrument until the instrument has been carefully placed back in to its enclosure.**

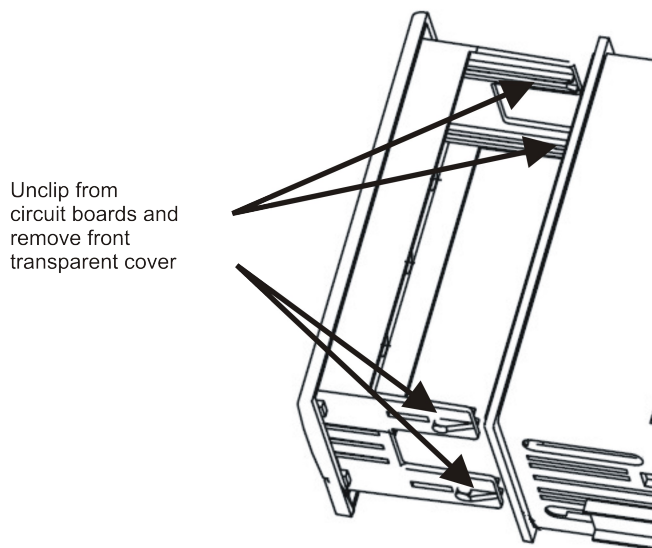

### 3.6 EMI Installation Guidelines

The instrument is designed with a high degree of immunity to EMI but the following guidelines will help in the successful installation of the instrument in the industrial environment. Cable length, routing and shielding can mean the difference between a successful or troublesome installation.

- Signal and control cables should be routed as far away as possible from contactors, DC motors etc.
- Never run signal or control cables in the same trunking as AC power lines or high current carrying conductors.
- Cables should be run in metal conduit that is grounded.
- Do not run cable near powerful radio transmitting devices eg. Two way radios.
- Keep cables as short as possible. Long cable runs are more susceptible to EMI then short run cables.
- Switching inductive loads cause high EMI. Use R-C Snubber networks or transient suppression devices across inductive loads.
- The instrument should be mounted in a grounded metal enclosure.
- Use shielded cables for all connections to the instrument. Some applications could require that one side of the screen is grounded.
- The use of external EMI suppression devices are recommended in high noise environments.

### 3.7 Power Supply Wiring

There are 3 different power supply variants! Please check which power supply is installed before connecting power by checking the marking on the sticker on the top of the instrument.

A universal mains switch mode power supply (85-264VAC) is provided as standard but an optional low voltage (10-30VDC) isolated power supply or a high voltage (25-70VDC) isolated power supply can be installed.

The instrument will consume a maximum of 10W with 4 load cells powered, all relays on, mA analog output fully loaded and all segments illuminated.

**WARNING** - The instrument is designed for installation in an enclosure which provides adequate protection against electric shock. Access to power terminals should be restricted to authorised skilled personnel only. Application of supply voltages higher than those for which the instrument is intended may compromise safety and can cause permanent damage.

#### AC Power Supply

Bottom Terminals

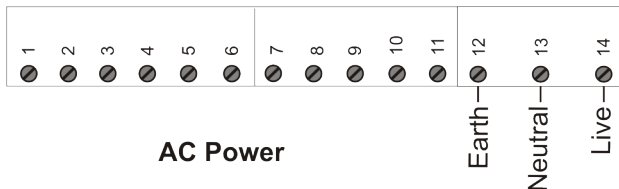

#### DC Power Supply

Bottom Terminals

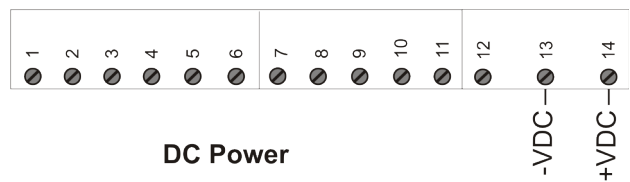

### 3.8 Fuse Replacement

The LT1240 contains a built in fuse. The fuse is a slow blow 2A Wickmann part number 3721200000. The fuse can also be purchased from RS Components part number 226-6599. The diagram below illustrates the position of the fuse on the main circuit board.

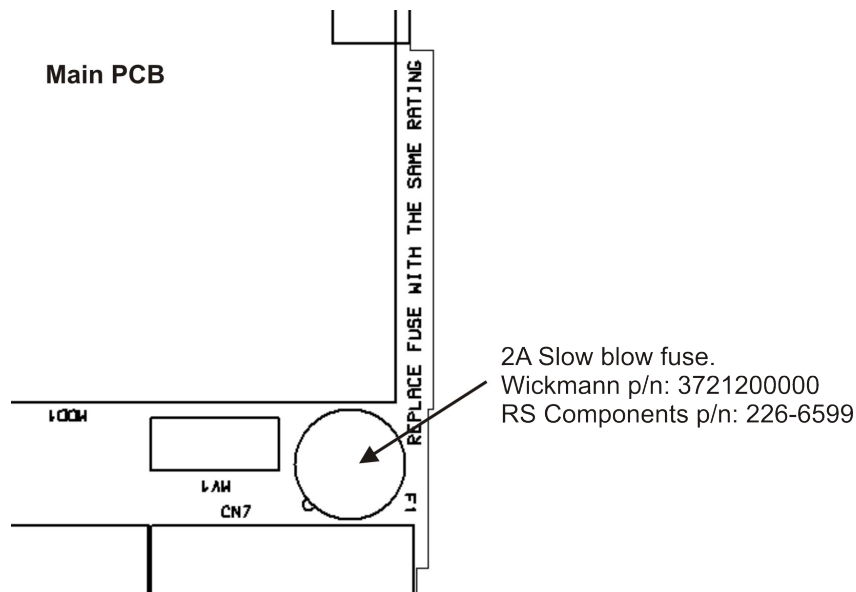

### 3.9 Load Cell Connection

The load cell should be connected to the instrument as in the diagrams below. When making connection to the load cell make sure you use screened cable connected to a ground point at one side only. Avoid running cables in the same trunking as high current/voltage cables and cables supplying DC motors or contactors etc.

It is recommended to use 6-wire load cells for the best results. When using 6-wire load cells make sure you connect the sense+ and sense- wires as close as possible to the load cell. The sense lines compensate for any voltage loss due to the wiring impedance.

If using 4-wire load cells then the sense+ must be connected to the excitation+ and the sense- must be connected to the excitation- as close as possible to the instrument.

### Automatic offset calibration

The LT1240 contains a unique feature in that it automatically does an offset calibration to cancel out any temperature effects in the electronics. This is to maintain optimum accuracy. The automatic offset calibration happens at power on as well as every few minutes. **Care must be taken to ensure that a load cell is connected before power is applied to the instrument otherwise an incorrect reading will be displayed until the next offset calibration takes place.**

### 4-Wire Load Cell Connection

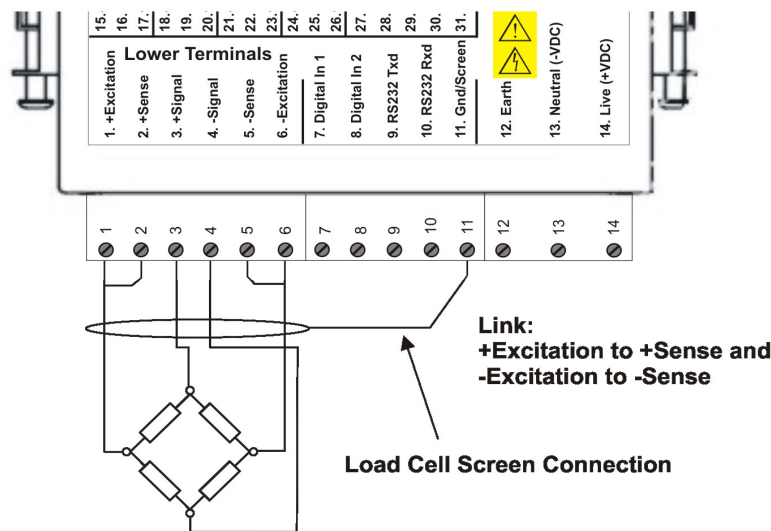

### 6-Wire Load Cell Connection

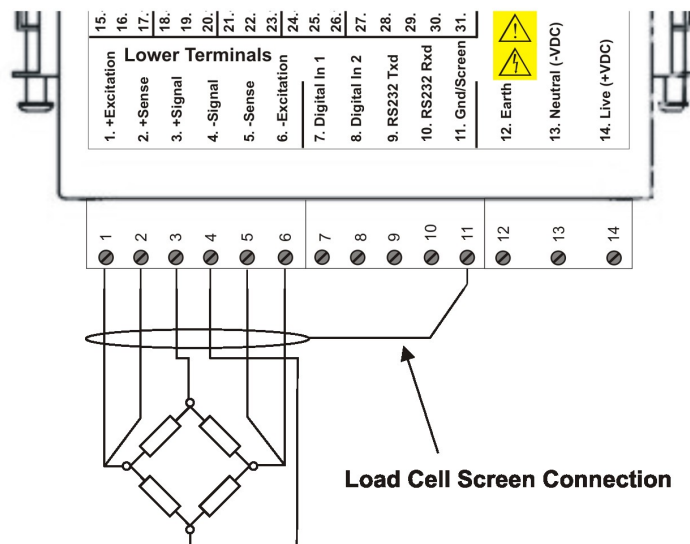

### Millivolt (mV) only input

If the LT1240 is used as a millivolt meter or if a true mV output calibrator is used then the input must be connected as in the diagram below. This is necessary to maintain the common mode voltage for the ratiometric ADC.

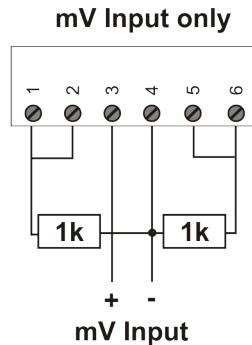

Link Exc+ to Sense+ and link Exc- to Sense-  
Set Signal - to midpoint using 2x 1k +/-1% resistors

### ADC Ratiometric input

The LT1240 uses a ratiometric ADC (Analog to Digital Converter) to obtain its precision. This means it uses the sense lines as the reference to the ADC. If the excitation voltage to the load cells varies (i.e. due to cable length, temperature etc) then the output voltage of the load cell will vary in proportion to the excitation voltage. This form of measurement improves the accuracy of the instrument and is perfectly suited for bridge circuits such as load cells.

### Load Cell Excitation Voltage

The LT1240 provides a stable built in 5VDC load cell excitation voltage. The LT1240 can power up to 6x350Ω load cells using 5VDC excitation. Connect the sense+ to excitation+ and sense- to excitation- if using a 4-wire load cell.

### 3.10 Digital Input connection

The LT1240 comes with 2 programmable digital inputs. The digital inputs can be used with either potential free contacts such as relay contacts, switches, transistor outputs or can be voltage driven. The inputs are not isolated from the instruments input circuitry. If the internal digital input jumper is set on pull up/sink input then the digital input line is pulled up to +5VDC with a 10kΩ resistor. If the internal digital input jumper is set on pull down/sourcing input then the digital input line is pulled down to ground with a 10kΩ resistor.

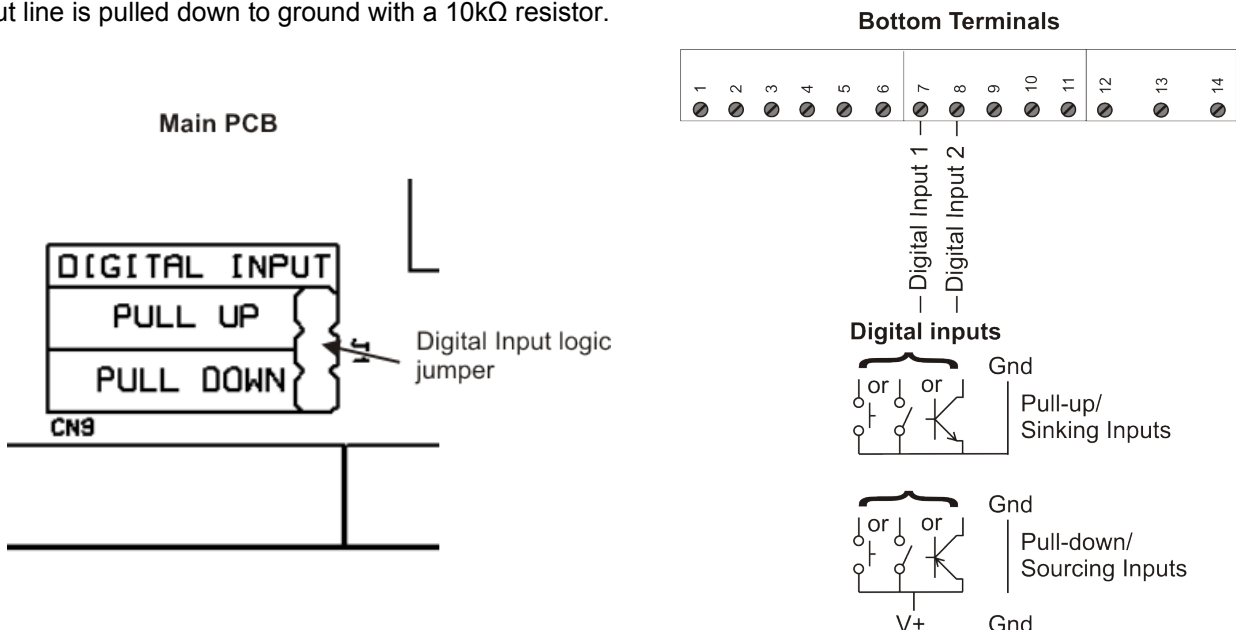

### 3.11 RS232 Communications

RS232 communications is standard on the LT1240. The RS232 protocol allows for a wired connection to be established as far as 100ft (30m). The RS232 port is also used for firmware upgrades.

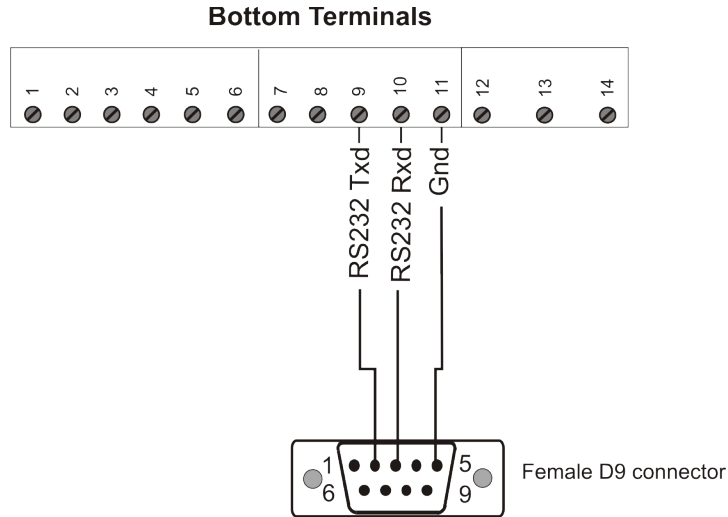

### 3.12 RS485 Communications (Optional)

The RS485 protocol allows for a wired connection to be established as far as 4000ft (1200m). RS232 only allows for a wired connection up to 100ft (30.5m). The LT1240 includes an on-board termination resistor which can be selected by linking J1 on the option circuit board inside the LT1240. The termination resistor is 120 Ohms.

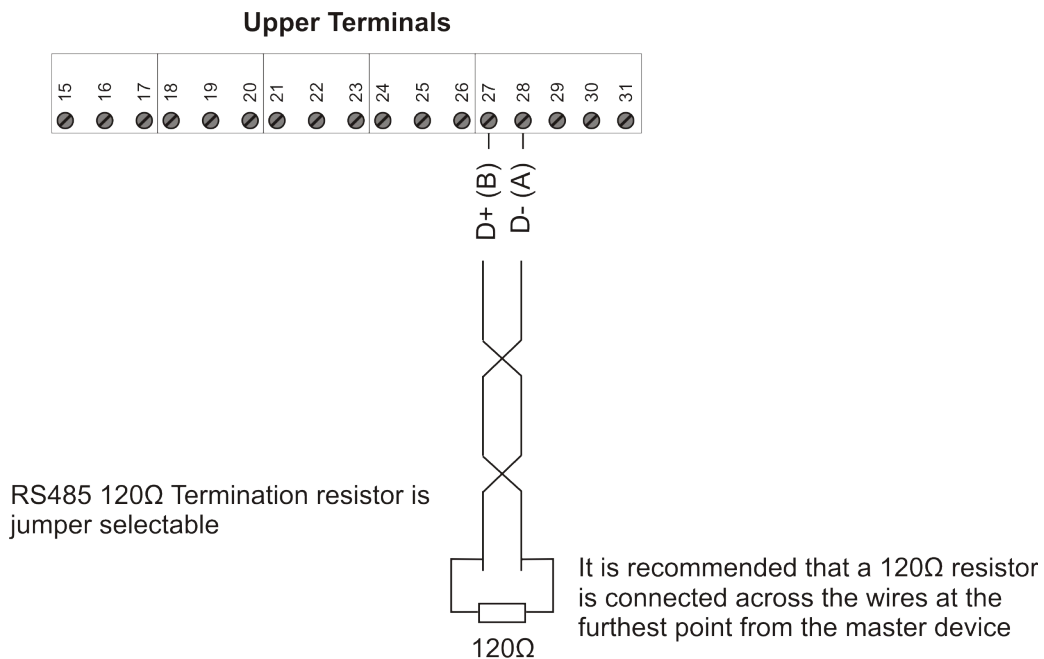

### RS485 Termination Resistor Location

The 120 Ohm termination resistor is field jumper selectable using J1 and is located on the top side of the option circuit board.

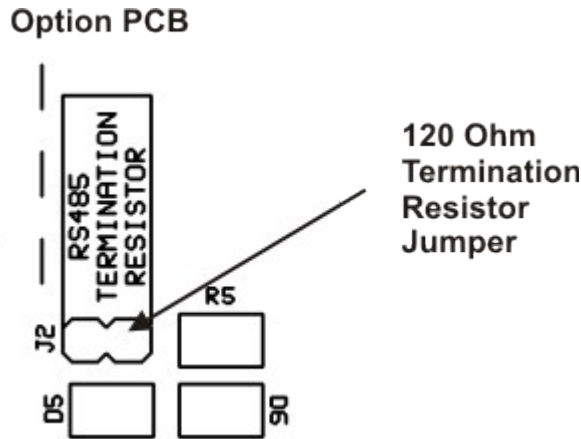

### 3.13 Mechanical Relays (Optional)

Up to 4 mechanical relays can be added as an option. Interposing relays are recommended for heavy duty applications. A R-C Snubber network or MOV maybe required for switching AC loads and a freewheeling diode or MOV maybe required for switching DC loads. An optional inductive load suppressor can be ordered and added to every relay output to suppress transient surges. Avoid running the alarm cables in the same trunking as the load cell cable.

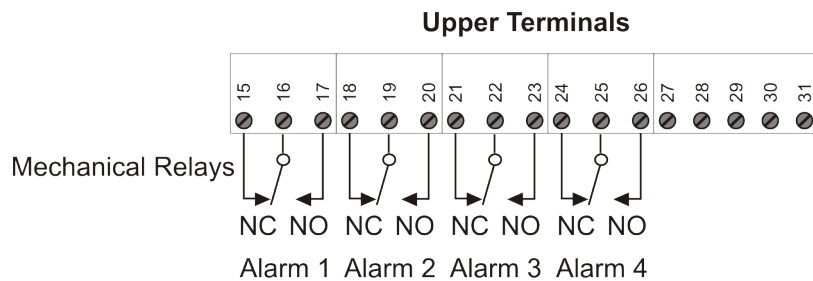

### 3.14 Solid-State Relays (Optional)

Up to 4 solid-state relays can be added as an option. Interposing relays are recommended for heavy duty applications. A R-C Snubber network or MOV maybe required for switching AC loads and a freewheeling diode or MOV maybe required for switching DC loads. An optional inductive load suppressor can be ordered and added to every relay output to suppress transient surges. Avoid running the alarm cables in the same trunking as the load cell cable.

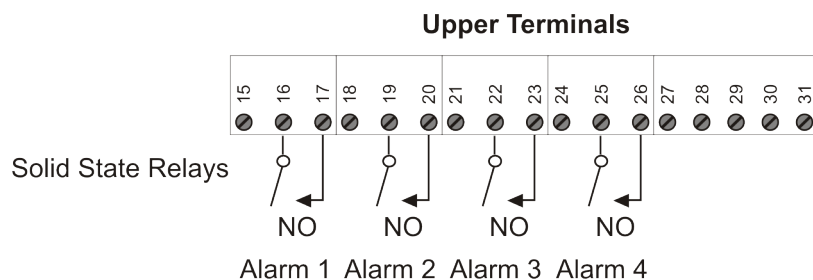

Noise suppression device for switching AC or DC devices

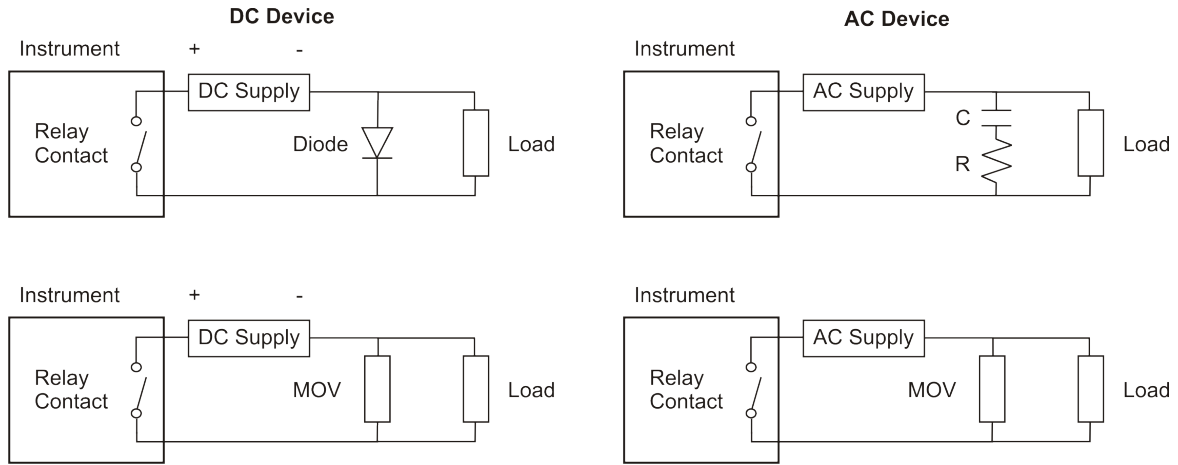

An optional noise suppression device can be ordered. Install these devices as close to the load as possible.

3.15 Analog Out / Isolated Analog Out (Optional)

Analog out or an Isolated analog out option can be fitted to the LT1240. The Analog out uses a high precision 16 bit DAC (Digital to Analog converter) to provide analog ranges of 0-20mA, 4-20mA and 0-10V. The current output is source, not sink and can drive a maximum of 500Ω. The voltage output can drive a minimum load of 1kΩ. The current output also has a unique open loop detection feature. If the current loop is broken then the words “mA.LOOP” will be briefly displayed on the display. Connect the analog out as in the diagram below.

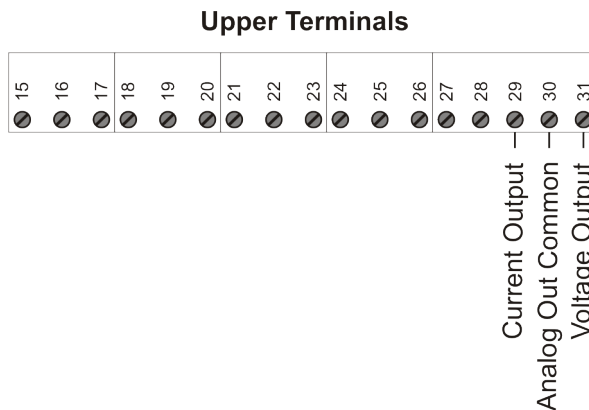

Analog Out mA Open Loop Error:

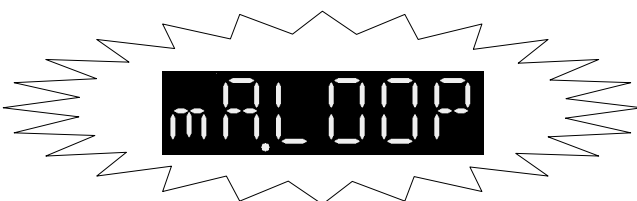

The display will flash the error message every 5 seconds to indicate that a mA loop error has occurred. This message will only be shown if the analog out option has been ordered and the analog out has been set for any of the mA ranges.



### 3.16 RTC Battery Replacement (Optional)

The internal battery will have to be replaced if the LT1240 loses its time when the instrument is switched off and on. The battery is of type CR2032. The battery is located on the underside of the option circuit board. The diagram below shows the location of the battery. The option PCB will have to be removed to replace the battery. Please see section 3.5 on how to add and remove the option circuit board.

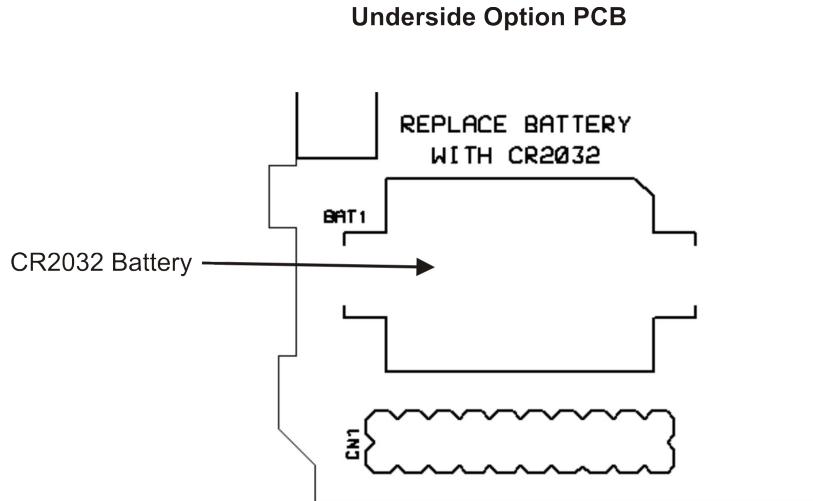



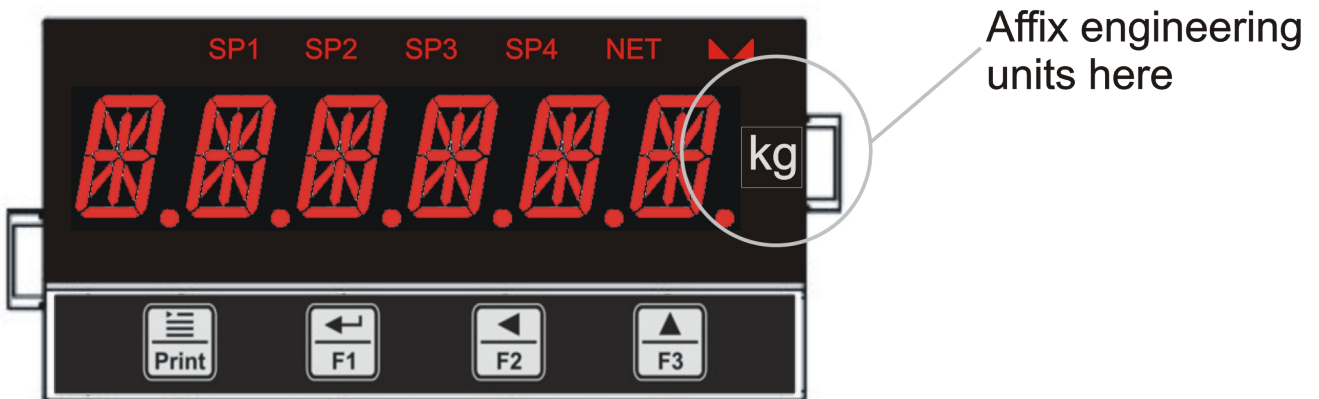

### 3.17 Engineering Units

Identify your display with one of the different engineering units. Simply select the appropriate label from the labeling sheet and apply it to the right hand side of the display as in the diagram below.



## 4 Menu System

The menu system can be entered by pressing and holding the menu button  for 3 seconds. Use the up , left

, enter  and back keys  to navigate through the menu system. All the settings are saved in non-volatile memory when exiting the menu system. The menu system has a 2 minute program timeout. If no key has been pressed within this period then the instrument will save all settings and return to the normal display mode.

### 4.1 Print Button

The menu/print button functions as the print button during the normal display mode. The print button is only enabled if either the RS232 or RS485 is set to the ASCII Out mode and the print on demand menu option has been selected. The display will briefly flash "PRINT" when the print button is pressed.

### 4.2 Built in Help Feature

The LT1240 includes a menu help feature which gives a better explanation of the menu option. If navigating the menu system and no keys are pressed within 10 seconds, then a help hint will be scrolled across the screen.

LC CFG

Wait 10 seconds



LOAD CELL SETUP MENU

Help hint will scroll across the display.

### 4.3 Editing and Entering Values

The instrument will occasionally prompt the user to enter a value by flashing the digit. Use the up, and left keys to change the value, enter to accept or menu to return back to the previous menu option.



Return



Enter/Accept



Next Digit



Increment Digit

Example:



Press the "Menu" key for 3 seconds to access the menu system.

SP 1



Press the "Enter" key to see the setpoint 1 value.



Press the "Up" key to increment the digit.



Press the "Left" key to edited the next digit.



Continue until the value has been set to the desired value.



Press the "Enter" key to accept the value and return to the menu system.



### 4.4 Main Menu

The main menu is entered by pressing and holding down the menu key for 3 seconds. The following will be displayed. Use the Up, Left, Enter and Menu keys to navigate the menu system.



Alarm 1 setpoint (Only shown if 1 or more alarm options have been ordered)



Press the "UP"  key to progress to the next menu option



Alarm 2 setpoint (Only shown if 2 or more alarm options have been ordered)



Alarm 3 setpoint (Only shown if 3 or more alarm options have been ordered)



Alarm 4 setpoint (Only shown if 4 alarm options have been ordered)



Load Cell configuration setup menu



Alarm configuration setup menu (Only shown if any of the alarm options have been ordered)



Analog output setup menu (Only shown if the analog output option has been ordered)



RS232 communications setup menu



RS485

RS485 communications setup menu (Only shown if the RS485 option has been ordered)



F KEYS

Function key setup menu



DIG.INP

Digital input setup menu



MISC

Miscellaneous items setup menu



EXIT

Exit menu. Settings are saved on menu exit and the instrument will return to the normal display mode



Back to the start of the main menu.

**Note:** The menu system has a 2 minute program timeout. If no key has been pressed within this period then the instrument will save all settings and return to the normal display mode.

### 4.5 Setpoint Values



The alarm setpoints are only shown if any of the alarm options have been ordered.



Use the front panel push buttons to adjust the alarm setpoint value.

### 4.6 Load Cell Configuration Menu









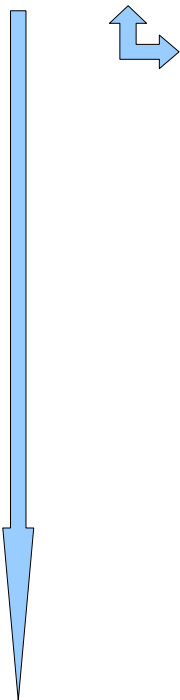

This menu configures the load cell parameters and also allows the user to calibrate the load cell system.



Select the engineering display units. The display units are used for the ASCII out printing and modbus communications.



-  No unit
-  Grams
-  Kilograms
-  Metric Tonnes
-  Ounces
-  Pounds
-  Imperial Tons
-  Newtons



Select the display decimal point.

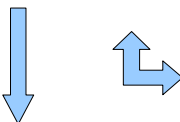

-  Use the up arrow to select the decimal point.

ROUND



Select the display rounding in display counts. The round function rounds the display value to the nearest rounding increment. Eg. With a rounding setting of 5, a display value of 233 will be rounded up to 235. A setting of "10" will create a dummy zero. The display rounding function can be used in conjunction with the digital filter settings to create a more stable display in noisy environments.

- 1
- 2
- 5
- 10
- 20
- 50

The LT1240 instrument contains an advanced digital filter algorithm. The filter works by filtering small changes between measurements but will react instantaneously to a large step response. There are 2 settings that are used to setup the digital filter, namely the filter band and the filter time. The filter band is the threshold in counts that the value must change by in order for the instrument to recognise it as a step response. The display will jump to this value immediately if a step response is detected. The filter time is the time in seconds that the input signal will be filtered provided that the input remains within the filter band setting. The filter is achieved by taking the moving average of the input signal for the filter time setting.

An increase in filter time leads to a more stable display but with a reduced reaction time. Use the filter time in conjunction with the filter band and display rounding settings to create a tradeoff between reaction time and display stability.

The diagram below illustrates the use of the filter time and the filter band.

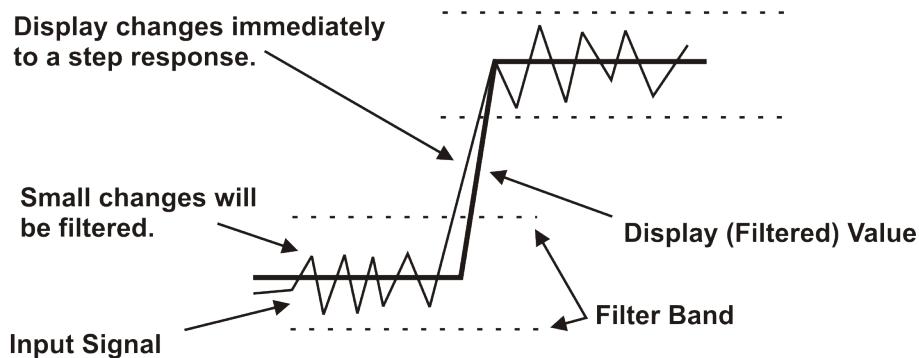

F BAND



See the paragraph above for an explanation of the filter band.

0 100

Use the front panel push buttons to enter the filter band.

F TIME

Select the filter time. See the paragraph above for an explanation of the filter time.

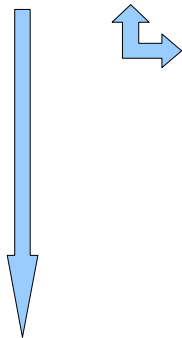

1 5

1 Second

3 5

3 Seconds

5 5

5 Seconds

10 5

10 Seconds

Z BAND

Enter the zero band setting. The auto-zero tracking and the manual gross zero will work within the limits of this band.

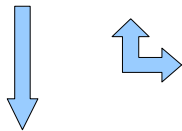

100

Use the front panel push buttons to enter the zero band.

MINMAX

Select the minimum and maximum assignment. The instrument will use this variable for the minimum and maximum comparison.

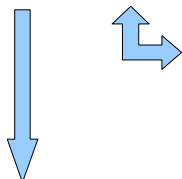

GROSS

Gross weight.

NET

Net weight.

LINEAR

Lineariser Sub-Menu

For non-linear processes, up to 16 scaling points may be used to provide a piece-wise linear approximation. The greater the number of points the greater the accuracy. Each point has a real value and a corresponding display value. The real value is the actual value of the input as it would be with the lineariser feature turned off, the display value is the desired value.

Setup the lineariser as follows:

- The instrument must be setup and calibrated as normal.
- Apply test signals and record the actual readings on the display.
- Activate the lineariser and enter the real values and its corresponding display/desired value.
- The instrument can be checked by applying the original test signal and verifying the display value.

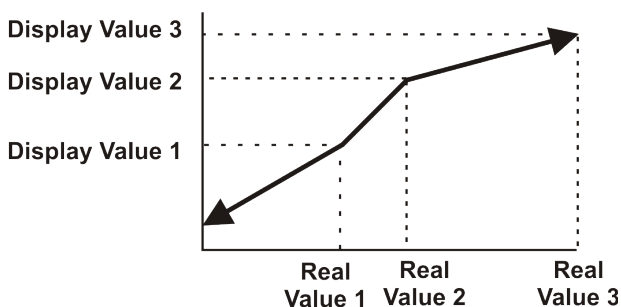

**Note:**

If the measured value is above the last actual point then the lineariser will use the last 2 points to calculate the slope and similarly is the measured value is below the first actual point then it will use the first 2 points to calculate the slope.



ENABLE

Select to enable the lineariser feature.

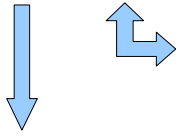

ON

The lineariser feature is turned on.

OFF

The lineariser feature is turned off.

POINTS

Select the number of lineariser scaling points.

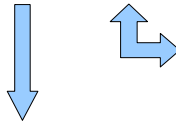

03

Use the up arrow to select the number of lineariser scaling points

REAL01

Enter the actual or real value.

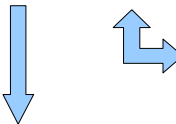

000000

Use the front panel push buttons to enter the actual or real value.

DISP01

Enter the display or desired value



000000

Use the front panel push buttons to enter the display or desired value.

A ZERO

Auto-Zero Tracking Sub-Menu

The auto-zero tracking feature will zero the weight display at regular intervals as long as the measured weight is within the zero band setting. The display will briefly flash "A.ZERO" when an auto-zero has been performed. When the instrument restarts, the auto zero correction is lost, but it will start again with a new auto zero correction. Manual zeroing can also be done via a front push button or via a rear digital input. The auto-zero tracking function can be used to compensate for zero drift. Zero drift may be caused by changes in the electronics or accumulation of material on the weight system. The auto-zero band should be set large enough to track normal zero drift, but small enough not to interfere with normal measuring.

The diagram to the right illustrates the use of the auto-zero tracking function.

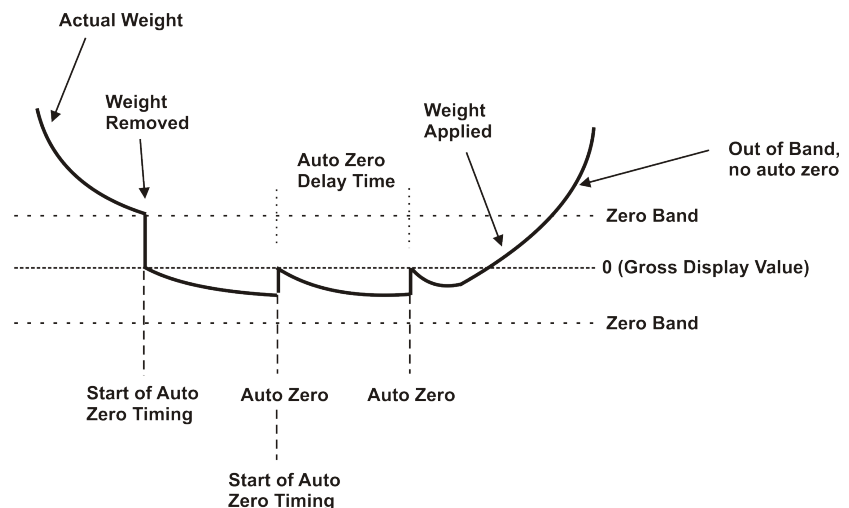

ENABLE

Select to enable the auto-zero tracking feature.

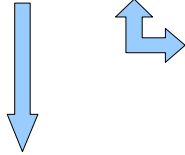

ON

Auto-zero tracking feature is turned on.

OFF

Auto-zero tracking feature is turned off.

DELAY

Auto-zero tracking delay time. This defines how often an auto zero is attempted.

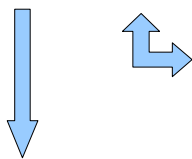

600

Use the front panel push buttons to enter the auto-zero tracking delay time in seconds.

Back to the start of the auto zero menu.

MOTION

Select the motion indication band. The display value must remain within the motion band for 1 second in order for the motion LED to illuminate. Select the value in display counts.

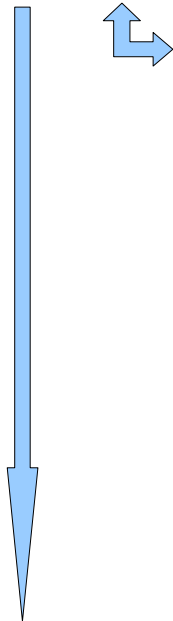

OFF

The motion indication is disabled.

1

2

3

5

10

20

50

Back to the start of the load cell configuration menu

### 4.6.1 Load Cell Calibration Sequence



The LT1240 can be calibrated by either using data from the load cell calibration certificate or by using known weights / load cell simulator.

#### Calibration using the load cell calibration certificate

The following parameters must be entered into the LT1240 from the load cell calibration certificate.



Enter the value in engineering units of the low calibration point of the system. This is normally zero.

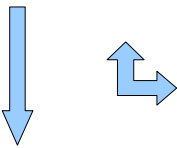

Use the front panel push buttons to enter the low display value.



Enter the value in engineering units of the high calibration point of the system eg. 5000kg. This is normally the full rating value of the load cells.

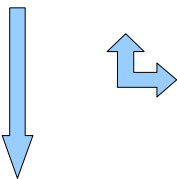

Use the front panel push buttons to enter the high display value.



Enter the value in mV/V that corresponds to the low display value. This value is normally found on the load cells calibration certificate. The load cells offset zero error is normally expressed as  $\mu\text{V}$  (microvolts) at 10V excitation. Eg. A load cell zero error with no load is 560 $\mu\text{V}$  (0.56mV) at 10V excitation. To convert to mV/V divide by 10 which equals 0.056mV. This value must then be entered into the low mV/V setting.

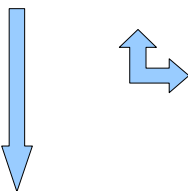

Use the front panel push buttons to enter the low mV/V value.



Enter the value in mV/V that corresponds to the high display value. This value is normally found on the load cells calibration certificate. The required value is the rated value of the load cell in mV/V at full load.

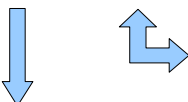

Use the front panel push buttons to enter the high mV/V value.



Calibration using known weights menu.



Back to the start of the load cell calibration menu.

Calibration using known weights



This allows the user to calibrate the LT1240 using known weights. Before the LT1240 can calculate the weight accurately it must know the the mV/V and display values of 2 known weights. The calibration sequence will prompt the user to apply known weights and enter the corresponding weight.

**For best results the system should be given a warm up time of a minimum of 15 minutes before calibration takes place and the 2 known weights should be as different from each other as possible to allow the LT1240 to try and obtain the greatest resolution. The high calibration mass should also be as close to the maximum system capacity as possible (Full load on the load cells)**

The low and high display and corresponding mV/V values can be entered manually in the "LC CAL" menu option.



This allows the user to enter and apply the low load cell calibration weight. The low weight is normally zero.

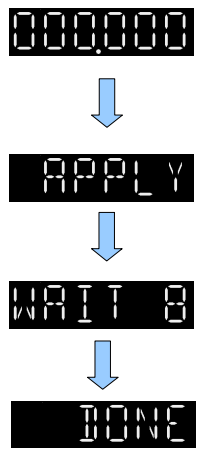
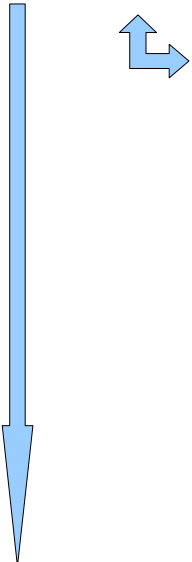

Use the front panel push buttons to enter the display value that corresponds to the low calibration weight.

Apply the low calibration weight to the scale and then press enter.

The LT1240 will start to average and calculate the mV/V value that corresponds to the low calibration weight.

Done! The low calibration weight can now be removed. The low display value and its corresponding mV/V value will be saved in the "LC CAL" menu settings.



This allows the user to enter and apply the high load cell calibration weight.

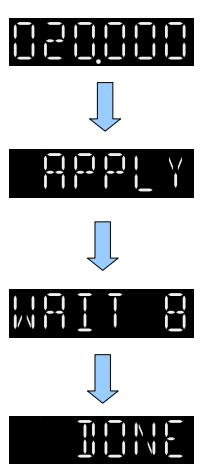
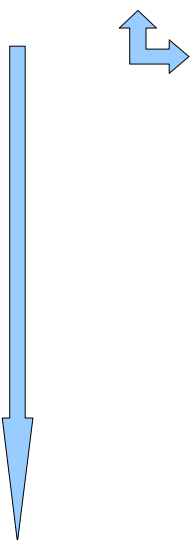

Use the front panel push buttons to enter the display value that corresponds to the high calibration weight.

Apply the high calibration weight to the scale and then press enter.

The LT1240 will start to average and calculate the mV/V value that corresponds to the high calibration weight.

Done! The high calibration weight can now be removed. The high display value and its corresponding mV/V value will be saved in the "LC CAL" menu settings.

Back to the start of the calibration using known weights menu.

**Calibrating using a Load Cell Simulator or mV simulator**

Calibrating the LT1240 using known weights is the most accurate way to calibrate the instrument. Other calibration equipment such as a load cell simulator or mV calibrator can also be used.

Using a load cell simulator is the easiest and best way to calibrate the LT1240 and this requires no additional interface circuitry because the load cell simulator will setup the common mode voltage required by the input to the ADC.

**The circuit as illustrated below must be constructed if trying to calibrate the LT1240 using a pure mV signal such that of a pure mV output calibrator. The resistors can be of a type 1k Ohm 1/4W 50ppm 1%. Please note that the resistor junction is only connected on the negative signal input. The below circuit is required to setup a common mode voltage for the ratiometric ADC.**

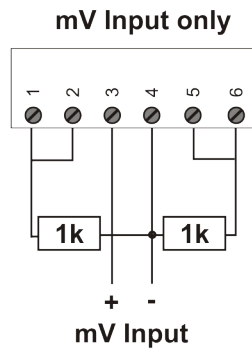

**Link Exc+ to Sense+ and link Exc- to Sense-  
Set Signal - to midpoint using 2x 1k +-1% resistors**

### 4.7 Alarm Configuration Menu



This menu configures the alarm parameters. This menu is only shown if any of the alarm options have been ordered.



The below setup menu is identical for each of the alarms.



Select the alarm assignment. The alarm will use this value to compare against the set point value.

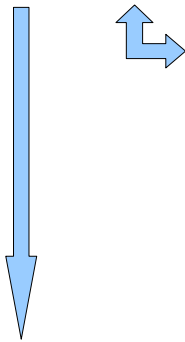

Gross weight.



Net weight.



Minimum weight recorded.



Maximum weight recorded.



Select the alarm mode.

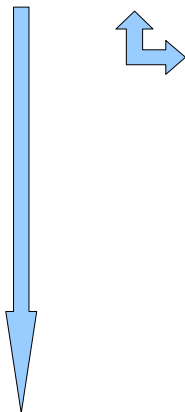

Alarm is disabled and the set point value is ignored.



Low acting alarm. A low alarm is activated when the measured value is below the alarm setpoint.



High acting alarm. A high alarm is activated when the measured value is higher then the alarm setpoint.



Deviation Alarm. A deviation alarm is activated when the measured value falls outside the deviation band.



Enter the deviation low value. The low value of the band is the set point minus the deviation low value. This menu option is only shown if the alarm mode is set to deviation.

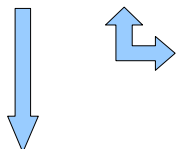

Use the front panel push buttons to enter the deviation low alarm.

DEL.HGH

Enter the deviation high value. The high value of the band is the set point plus the deviation high value. This menu option is only shown if the alarm mode is set to deviation.

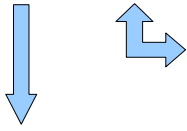

0.100

Use the front panel push buttons to enter the deviation high alarm.

LOGIC

Select the alarm logic.

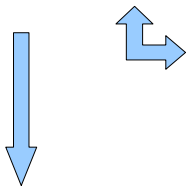

NORMAL

Alarm logic is normal.

INVERT

Alarm logic is inverted.

HYST

Enter the alarm hysteresis value. The hysteresis value is normally used to prevent an alarm being activated and deactivated when a noisy measurement dithers around the set point value.

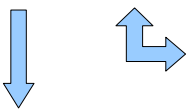

0001

Use the front panel push buttons to enter the hysteresis value.

DEL.ON

Enter the alarm on delay value in seconds that the alarm condition must persist before the alarm is activated.

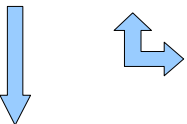

0000

Use the front panel push buttons to enter the alarm on delay.

DEL.OFF

Enter the alarm off delay value in seconds that the alarm condition must persist before the alarm is de-activated.

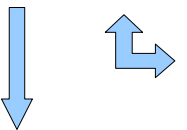

0000

Use the front panel push buttons to enter the alarm off delay.

LATCH

The alarm can be set to remain activated even if the alarm condition has gone. When the alarm condition has gone then the alarm latch can be reset by either a digital input or via the front push buttons.

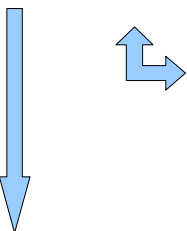

ON

Alarm latch function is turned on.

OFF

Alarm latch function is turned off.

Back to the start of the alarm configuration menu.

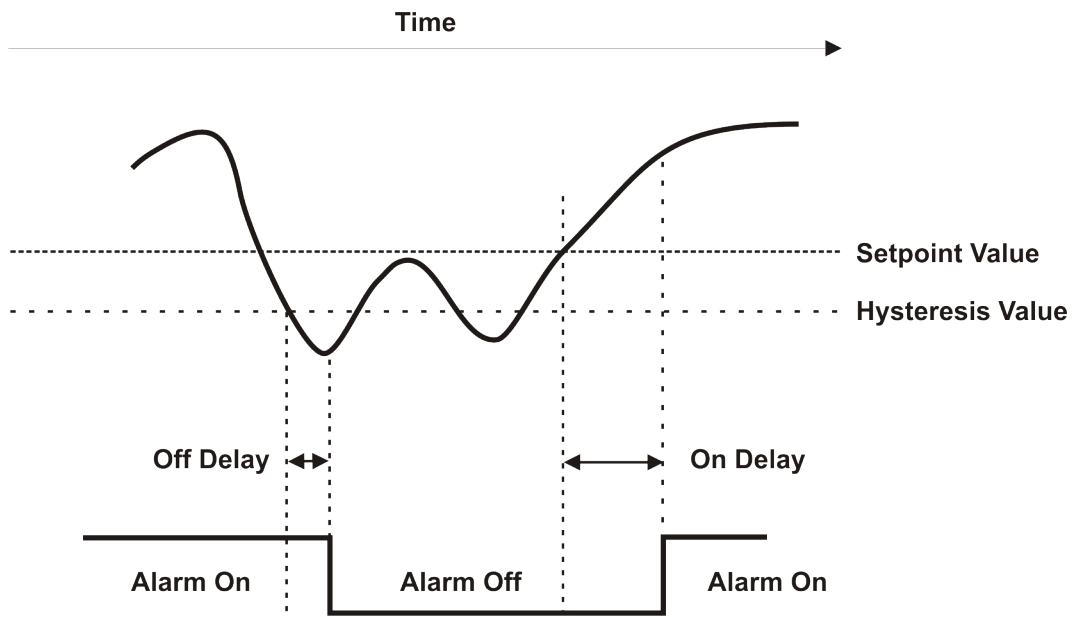

The above diagram illustrates the use of a high alarm with hysteresis and on/off delay.

### 4.8 Analog Out Configuration Menu







This menu configures the analog output parameters. This menu is only shown if the analog output option has been ordered.

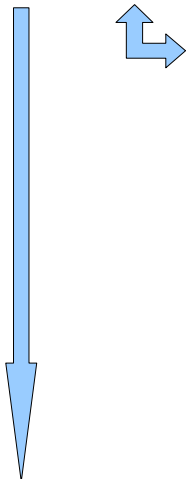

Select the source for the analog retransmission.



-  Gross weight
-  Net weight
-  Minimum weight recorded
-  Maximum weight recorded



TYPE

Select the analog out type.

OFF

The Analog output is disabled.

0-20mA

The analog output will be set to 0 to 20mA

4-20mA

The analog output will be set to 4 to 20mA

0-10V

The analog output will be set to 0 to 10V

AN. LOW

Enter the analog output low value.

000000

Use the front panel push buttons to enter the display value that corresponds to the selected analog out low value E.G. 0.000 display counts = 4mA.

AN.HIGH

Enter the analog output high value.

020000

Use the front panel push buttons to enter the display value that corresponds to the selected analog out low value E.G. 20.000 display counts = 20mA.

AN. ERR

Enter what must happen to the analog output when an error occurs with the measured weight. eg. Over-range, Under-Range etc.

OFF

Analog error output is disabled.

AN. LOW

The analog output will go to the analog low value when an error condition occurs.

AN.HIGH

The analog output will go to the analog high value when an error condition occurs.

Back to the start of the analog out configuration menu.

## 4.9 RS232/RS485 Configuration Menu



This menu configures the RS232 and RS485 serial port parameters. The RS232 communication port is standard on the LT1240 but the RS485 menu will only be shown if the RS485 option has been ordered.

The LT1240 has 3 built in communication protocols:

- 1) MODBUS™ RTU
- 2) MODBUS™ ASCII
- 3) Infiniteq ASCII protocol for interfacing to large displays and serial printers.

Please see below for the LT1240 MODBUS registers.



Select the communication protocol.

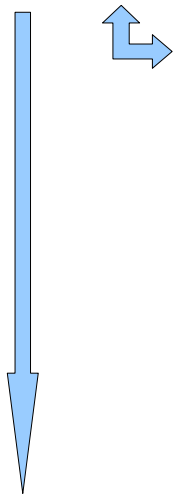

ASCII out protocol. A simple ASCII protocol to interface to serial printers and large displays. Please see the format of the ASCII out protocol in section 4.9.1



ASCII in protocol. The LT1240 can act as a slave indicator to another LT1240 instrument. One LT1240 instrument must be setup for continuous ASCII Out and the other LT1240 must be setup for ASCII IN.



Modbus RTU protocol. See section for more details.



Modbus ASCII protocol. See section for more details.



Enter the communication address of the instrument. If more than one instrument is connected via a multidrop network then the address of each instrument must be unique. A unique address allows commands to be sent to an individual instrument as well as it also prevents all the instruments on the bus replying simultaneously.

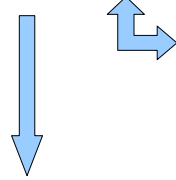

The ASCII out protocol address range is 0 to 255. The Modbus address range is 001 to 247. Use the front panel push buttons to enter the unit address.



Select the communication baud rate.

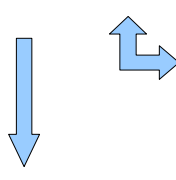



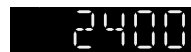

1200 Baud.



2400 Baud.

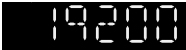

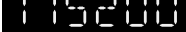

-  4800 Baud.
-  9600 Baud.
-  19200 Baud.
-  38.4k Baud.
-  57.6k Baud.
-  115.2k Baud.

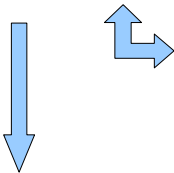

Select the communication data bits





-  7 data bits.
-  8 data bits.

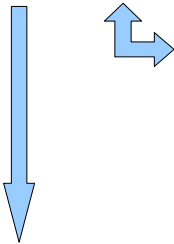

Select the communication parity.

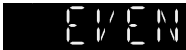

-  No parity.
-  Even parity.
-  Odd parity.



Select the communication stop bits.

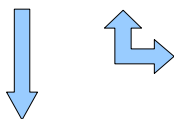



-  1 Bit.
-  2 Bits.

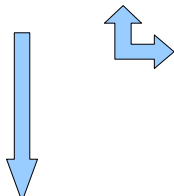

Select the source for the communication data. This menu option is only shown if the ASCII Out mode is selected



-  Gross weight
-  Net weight

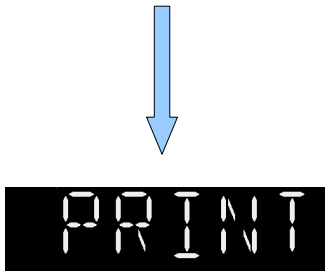

MIN

Minimum weight recorded

MAX

Maximum weight recorded

This menu option is only shown if the ASCII Out mode is selected.

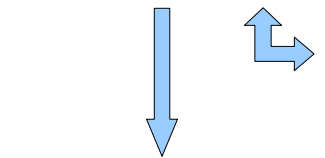

DEMAND

Print on demand by either pressing the front push button or by a digital input.

CONT

Continuous printing. The instrument will transmit the ASCII string at a rate of 5 times a second.



This menu option enables the date and time to be included in the ASCII output string. This menu option is only shown if the ASCII Out mode is selected and the RTC option has been ordered.

OFF

The date and time information is not included in the ASCII output string.

ON

The date and time information is included in the ASCII output string.



This menu option sets the communication timeout period. If no valid communications is received within the timeout period then the display will flash to indicate an error. This menu option is only shown if the ASCII In mode has been selected.

001

Enter the communication timeout period in seconds.

Back to the start of the RS232 or RS485 configuration menu.

### 4.9.1 ASCII Out Protocol

**Example: \*123 12:23:45 01/01/2011 N +123456.78 kg**

<\*> = Decimal 42

<AAA><SPACE> (Only transmitted if address > 0)

<HH:MM:SS><SPACE><DD/MM/YYYY><SPACE> (Optional field if RTC selected) = Time & Date

<G/N><SPACE> = G=Gross, N=Net

<10 digits right justified, leading zero suppression, including decimal point and polarity>

<SPACE> = Decimal 32

<UNIT>=

None=Unit not transmitted, g, kg, t, oz, lb, T, N

<CR> = Decimal 13

<LF> = Decimal 10

### 4.9.2 The Modbus Protocol

The IQ series instruments modbus implementation is based on the following documents:

“MODBUS over Serial Line Specification and Implementation Guide V1.02” from Modbus-IDA.ORG.

And

“MODBUS Application Protocol Specification V1.1b” from Modbus-IDA.ORG.

Details of the Modbus protocol is described in these documents and is available for free download from the following website URLs:

[http://modbus-ida.org/docs/Modbus\\_over\\_serial\\_line\\_V1\\_02.pdf](http://modbus-ida.org/docs/Modbus_over_serial_line_V1_02.pdf)

<http://www.infiniteq.co.za/manuals.aspx>

### 4.9.3 Modbus Commands

The IQ series of instruments supports the following Modbus commands:

FC03 (0x03) – Read Holding Registers

FC05 (0x05) – Write Single Coil

FC06 (0x06) – Write Single Holding Register

**Note:** Broadcast read commands are ignored by the indicator, only broadcast write commands are processed.

#### Supported Modbus Error Messages:

Error Code	Error Description
0x01	Illegal function code
0x02	Illegal register address
0x03	Illegal data value or data length

### 4.9.4 Modbus Register Addresses

#### Read Holding Register (FC03), Write Single Holding Register (FC06):

Referenced to 4XXXX.

Address	Data Type	Operation	Description
0	32 bit unsigned	R	Serial Number High Word
1	32 bit unsigned	R	Serial Number Low Word

2	8 bit unsigned	R	Model Number
3	16 bit unsigned	R	Firmware Version
4	32 bit signed	R	ADC Zero mV/V calibration constant High word
5	32 bit signed	R	ADC Zero mV/V calibration constant Low word
6	32 bit signed	R	ADC Span mV/V calibration constant High word
7	32 bit signed	R	ADC Span mV/V calibration constant Low word
50	32 bit signed	R/W	Alarm 1 Setpoint High Word
51	32 bit signed	R/W	Alarm 1 Setpoint Low Word
52	8 bit unsigned	R/W	Alarm 1 Assignment 0: Gross 1: Net 2: Min 3: Max
53	8 bit unsigned	R/W	Alarm 1 Mode 0: Off 1: Low 2: High
54	8 bit unsigned	R/W	Alarm 1 logic 0: Normal 1: Inverted
55	16 bit unsigned	R/W	Alarm 1 Hysteresis
56	16 bit unsigned	R/W	Alarm 1 Deviation low
57	16 bit unsigned	R/W	Alarm 1 Deviation High
58	16 bit unsigned	R/W	Alarm 1 On Delay
59	16 bit unsigned	R/W	Alarm 1 Off Delay
60	8 bit unsigned	R/W	Alarm 1 Latch 0: Off 1: On
70	32 bit signed	R/W	Alarm 2 Setpoint High Word
71	32 bit signed	R/W	Alarm 2 Setpoint Low Word
72	8 bit unsigned	R/W	Alarm 2 Assignment 0: Gross 1: Net 2: Min 3: Max
73	8 bit unsigned	R/W	Alarm 2 Mode 0: Off 1: Low 2: High
74	8 bit unsigned	R/W	Alarm 2 logic 0: Normal 1: Inverted
75		R/W	Alarm 2 Hysteresis
76	16 bit unsigned	R/W	Alarm 2 On Delay
77	16 bit unsigned	R/W	Alarm 2 Deviation low

78	16 bit unsigned	R/W	Alarm 2 Deviation High
79	16 bit unsigned	R/W	Alarm 2 Off Delay
80	8 bit unsigned	R/W	Alarm 2 Latch 0: Off 1: On
90	32 bit signed	R/W	Alarm 3 Setpoint High Word
91	32 bit signed	R/W	Alarm 3 Setpoint Low Word
92	8 bit unsigned	R/W	Alarm 3 Assignment 0: Gross 1: Net 2: Min 3: Max
93	8 bit unsigned	R/W	Alarm 3 Mode 0: Off 1: Low 2: High
94	8 bit unsigned	R/W	Alarm 3 logic 0: Normal 1: Inverted
95	16 bit unsigned	R/W	Alarm 3 Hysteresis
96	16 bit unsigned	R/W	Alarm 3 Deviation low
97	16 bit unsigned	R/W	Alarm 3 Deviation High
98	16 bit unsigned	R/W	Alarm 3 On Delay
99	16 bit unsigned	R/W	Alarm 3 Off Delay
100	8 bit unsigned	R/W	Alarm 3 Latch 0: Off 1: On
110	32 bit signed	R/W	Alarm 4 Setpoint High Word
111	32 bit signed	R/W	Alarm 4 Setpoint Low Word
112	8 bit unsigned	R/W	Alarm 4 Assignment 0: Gross 1: Net 2: Min 3: Max
113	8 bit unsigned	R/W	Alarm 4 Mode 0: Off 1: Low 2: High
114	8 bit unsigned	R/W	Alarm 4 logic 0: Normal 1: Inverted
115	16 bit unsigned	R/W	Alarm 4 Hysteresis
116	16 bit unsigned	R/W	Alarm 4 Deviation low
117	16 bit unsigned	R/W	Alarm 4 Deviation High
118	16 bit unsigned	R/W	Alarm 4 On Delay
119	16 bit unsigned	R/W	Alarm 4 Off Delay

120	8 bit unsigned	R/W	Alarm 4 Latch 0: Off 1: On
130	8 bit unsigned	R/W	Analog Out Assignment 0: Gross 1: Net
131	8 bit unsigned	R/W	Analog Out Type 0: 0 to 20mA 1: 4 to 20mA 2: 0 to 10V 3: Off
132	16 bit unsigned	R/W	Analog Out Low Value High Word
133	16 bit unsigned	R/W	Analog Out Low Value Low Word
134	16 bit unsigned	R/W	Analog Out High Value High Word
135	16 bit unsigned	R/W	Analog Out High Value High Word
136	8 bit unsigned	R/W	Analog Out Error 0: Off 1: Analog Low 2: Analog High
140	8 bit unsigned	R/W	Com Address
141	8 bit unsigned	R/W	COM 1 (RS232) Protocol 0: ASCII Out 1: ASCII In 2: Modbus RTU 3: Modbus ASCII
142	8 bit unsigned	R/W	COM 1 (RS232) ASCII Out Assignment 0: Gross 1: Net
143	8 bit unsigned	R/W	COM 1 (RS232) ASCII Out Mode 0: On Demand 1: Continuous
144	8 bit unsigned	R/W	COM 1 (RS232) ASCII Out RTC 0: Off 1: On
145	8 bit unsigned	R/W	COM 1 (RS232) Baud 0: 1200 1: 2400 2: 4800 3: 9600 4: 19200 5: 38400 6: 57600 7: 115200
146	8 bit unsigned	R/W	COM 1 (RS232) Data Bits 0: 7 Bits 1: 8 Bits
147	8 bit unsigned	R/W	COM 1 (RS232) Parity 0: None 1: Even 2: Odd



148	8 bit unsigned	R/W	COM 1 (RS232) Stop bits 0: 1 Stop Bit 1: 2 Stop Bits
160	8 bit unsigned	R/W	COM 2 (RS485) Protocol 0: ASCII Out 1: ASCII In 2: Modbus RTU 3: Modbus ASCII
161	8 bit unsigned	R/W	COM 2 (RS485) ASCII Out Assignment 0: Gross 1: Net
162	8 bit unsigned	R/W	COM 2 (RS485) ASCII Out Mode 0: On Demand 1: Continuous
163	8 bit unsigned	R/W	COM 2 (RS485) ASCII Out RTC 0: Off 1: On
164	8 bit unsigned	R/W	COM 2 (RS485) Baud 0: 1200 1: 2400 2: 4800 3: 9600 4: 19200 5: 38400 6: 57600 7: 115200
165	8 bit unsigned	R/W	COM 2 (RS485) Data Bits 0: 7 Bits 1: 8 Bits
166	8 bit unsigned	R/W	COM 2 (RS485) Parity 0: None 1: Even 2: Odd
167	8 bit unsigned	R/W	COM 2 (RS485) Stop bits 0: 1 Stop Bit 1: 2 Stop Bits
180	8 bit unsigned	R/W	F1 Key Assignment 0: None 1: Min/Max Toggle 2: Min/Max Value Reset 3: Latch Reset 4: Gross/Net 5: Zero 6: Tare 7: Edit SP1 8: Edit SP2 9: Edit SP3 10: Edit SP4 11: Display Hold
181	8 bit unsigned	R/W	F2 Key Assignment 0: None 1: Min/Max Toggle 2: Min/Max Value Reset

			3: Latch Reset 4: Gross/Net 5: Zero 6: Tare 7: Edit SP1 8: Edit SP2 9: Edit SP3 10: Edit SP4 11: Display Hold
182	8 bit unsigned	R/W	F3 Key Assignment 0: None 1: Min/Max Toggle 2: Min/Max Value Reset 3: Latch Reset 4: Gross/Net 5: Zero 6: Tare 7: Edit SP1 8: Edit SP2 9: Edit SP3 10: Edit SP4 11: Display Hold
190	8 bit unsigned	R/W	Digital Input 1 Assignment 0: None 1: Min/Max Toggle 2: Min/Max Value Reset 3: Latch Reset 4: Gross/Net 5: Zero 6: Tare 7: Display Hold
191	8 bit unsigned	R/W	Digital Input 2 Assignment 0: None 1: Min/Max Toggle 2: Min/Max Value Reset 3: Latch Reset 4: Gross/Net 5: Zero 6: Tare 7: Display Hold
200	8 bit unsigned	R/W	Code Level 0: Only Alarms Setpoints not locked 1: Full Lockout
201	16 bit unsigned	R/W	Password
202	16 bit unsigned	R/W	Set RTC Date Years
203	8 bit unsigned	R/W	Set RTC Date Months
204	8 bit unsigned	R/W	Set RTC Date Days
205	8 bit unsigned	R/W	Set RTC Time Hours
206	8 bit unsigned	R/W	Set RTC Time Minutes
207	8 bit unsigned	R/W	Set RTC Time Seconds
300	8 bit unsigned	R/W	Lineariser Enable

301	8 bit unsigned	R/W	Lineariser Points
302	32 bit signed	R/W	Lineariser Real Point 1 High Word
303	32 bit signed	R/W	Lineariser Real Point 1 Low Word
304	32 bit signed	R/W	Lineariser Real Point 2 High Word
305	32 bit signed	R/W	Lineariser Real Point 2 Low Word
306	32 bit signed	R/W	Lineariser Real Point 3 High Word
307	32 bit signed	R/W	Lineariser Real Point 3 Low Word
308	32 bit signed	R/W	Lineariser Real Point 4 High Word
309	32 bit signed	R/W	Lineariser Real Point 4 Low Word
310	32 bit signed	R/W	Lineariser Real Point 5 High Word
311	32 bit signed	R/W	Lineariser Real Point 5 Low Word
312	32 bit signed	R/W	Lineariser Real Point 6 High Word
313	32 bit signed	R/W	Lineariser Real Point 6 Low Word
314	32 bit signed	R/W	Lineariser Real Point 7 High Word
315	32 bit signed	R/W	Lineariser Real Point 7 Low Word
316	32 bit signed	R/W	Lineariser Real Point 8 High Word
317	32 bit signed	R/W	Lineariser Real Point 8 Low Word
318	32 bit signed	R/W	Lineariser Real Point 9 High Word
319	32 bit signed	R/W	Lineariser Real Point 9 Low Word
320	32 bit signed	R/W	Lineariser Real Point 10 High Word
321	32 bit signed	R/W	Lineariser Real Point 10 Low Word
322	32 bit signed	R/W	Lineariser Real Point 11 High Word
323	32 bit signed	R/W	Lineariser Real Point 11 Low Word
324	32 bit signed	R/W	Lineariser Real Point 12 High Word
325	32 bit signed	R/W	Lineariser Real Point 12 Low Word
326	32 bit signed	R/W	Lineariser Real Point 13 High Word
327	32 bit signed	R/W	Lineariser Real Point 13 Low Word
328	32 bit signed	R/W	Lineariser Real Point 14 High Word
329	32 bit signed	R/W	Lineariser Real Point 14 Low Word
330	32 bit signed	R/W	Lineariser Real Point 15 High Word
331	32 bit signed	R/W	Lineariser Real Point 15 Low Word
332	32 bit signed	R/W	Lineariser Real Point 16 High Word
333	32 bit signed	R/W	Lineariser Real Point 16 Low Word
334	32 bit signed	R/W	Lineariser Display Point 1 High Word
335	32 bit signed	R/W	Lineariser Display Point 1 High Word
336	32 bit signed	R/W	Lineariser Display Point 2 High Word
337	32 bit signed	R/W	Lineariser Display Point 2 High Word
338	32 bit signed	R/W	Lineariser Display Point 3 High Word
339	32 bit signed	R/W	Lineariser Display Point 3 High Word
340	32 bit signed	R/W	Lineariser Display Point 4 High Word
341	32 bit signed	R/W	Lineariser Display Point 4 High Word

342	32 bit signed	R/W	Lineariser Display Point 5 High Word
343	32 bit signed	R/W	Lineariser Display Point 5 High Word
344	32 bit signed	R/W	Lineariser Display Point 6 High Word
345	32 bit signed	R/W	Lineariser Display Point 6 High Word
346	32 bit signed	R/W	Lineariser Display Point 7 High Word
347	32 bit signed	R/W	Lineariser Display Point 7 High Word
348	32 bit signed	R/W	Lineariser Display Point 8 High Word
349	32 bit signed	R/W	Lineariser Display Point 8 High Word
350	32 bit signed	R/W	Lineariser Display Point 9 High Word
351	32 bit signed	R/W	Lineariser Display Point 9 High Word
352	32 bit signed	R/W	Lineariser Display Point 10 High Word
353	32 bit signed	R/W	Lineariser Display Point 10 High Word
354	32 bit signed	R/W	Lineariser Display Point 11 High Word
355	32 bit signed	R/W	Lineariser Display Point 11 High Word
356	32 bit signed	R/W	Lineariser Display Point 12 High Word
357	32 bit signed	R/W	Lineariser Display Point 12 High Word
358	32 bit signed	R/W	Lineariser Display Point 13 High Word
359	32 bit signed	R/W	Lineariser Display Point 13 High Word
360	32 bit signed	R/W	Lineariser Display Point 14 High Word
361	32 bit signed	R/W	Lineariser Display Point 14 High Word
362	32 bit signed	R/W	Lineariser Display Point 15 High Word
363	32 bit signed	R/W	Lineariser Display Point 15 High Word
364	32 bit signed	R/W	Lineariser Display Point 16 High Word
365	32 bit signed	R/W	Lineariser Display Point 16 High Word
400	8 bit unsigned	R/W	Load Cell Unit
401	8 bit unsigned	R/W	Load Cell Decimal Point
402	8 bit unsigned	R/W	Load Cell Display Step Increment
403	8 bit unsigned	R/W	Load Cell Filter Time
404	8 bit unsigned	R/W	Load Cell Zero Band
405	32 bit signed	R/W	Load Cell Low Display High Word
406	32 bit signed	R/W	Load Cell Low Display Low Word
407	32 bit signed	R/W	Load Cell High Display High Word
408	32 bit signed	R/W	Load Cell High Display Low Word
409	32 bit signed	R/W	Load Cell Low Display mV/V High Word
410	32 bit signed	R/W	Load Cell Low Display mV/V Low Word
411	32 bit signed	R/W	Load Cell High Display mV/V High Word
412	32 bit signed	R/W	Load Cell High Display mV/V Low Word
413	16 bit unsigned	R/W	Load Cell Zero Band
414	8 bit unsigned	R/W	Load Cell Auto Zero Enable
415	16 bit unsigned	R/W	Load Cell Auto Zero Delay

416	8 bit unsigned	R/W	Load Cell Min/Max Assignment
417	8 bit unsigned	R/W	Load Cell Motion Band
418	32 bit signed	R/W	Load Cell Tare Value High Word
419	32 bit signed	R/W	Load Cell Tare Value Low Word
420	32 bit signed	R	Load Cell Gross Value High Word
421	32 bit signed	R	Load Cell Gross Value Low Word
422	32 bit signed	R	Load Cell Net Value High Word
423	32 bit signed	R	Load Cell Net Value Low Word
424	32 bit signed	R	Load Cell Minimum Value High Word
425	32 bit signed	R	Load Cell Minimum Value Low Word
426	32 bit signed	R	Load Cell Maximum Value High Word
427	32 bit signed	R	Load Cell Maximum Value Low Word

**FC05: Write Single Coil**

Referenced to 0XXXX. A value of 0xFF00 for the data will execute the function. An Echo of the original message will be returned.

<b>Address</b>	<b>Action Command</b>
0	Instrument Reset
1	Load Default Settings
2	Latched Alarm Reset
3	Min/Max Value Reset
4	0xFF00=Display Hold, 0x0000=Normal
5	Display Minimum Value
6	Display Maximum Value
7	Activate External Input 1
8	Activate External Input 2
9	Set RTC
10	Execute Zero
11	Execute Tare
12	Display Gross
13	Display Net

### 4.10 Function Key Configuration Menu



This menu configures the front panel function key push buttons. Three of the front panel push buttons can be user configured for specific functions as listed below.



The function key is disabled.



The function key will toggle the display in the following order. The minimum recorded weight, the maximum recorded weight and then the current measured weight value. The display will flash either "MIN" or "MAX" to indicate that the displayed value is either the minimum or maximum recorded weight.



The function key will reset the minimum and maximum recorded values to the current measured weight value.



The function key will reset any of the latched alarms when the alarm condition has been removed. This menu option is only displayed if any of the alarm options have been ordered and the alarm latch function has been activated.



The function key will toggle the display between showing the gross and net weight. The net status indicator will illuminate to indicate that the display is showing the net weight.

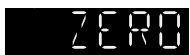

This function will perform a manual zero within the zero band setting. This is a useful function if there is some residue material left on the scale.



The function key will tare the gross weight and it will then automatically swap the display to show the net value. The net status indicator will illuminate to indicate that the display is showing the net weight.



The function key will allow the user to edit the alarm 1 setpoint value. This menu option is only displayed if any of the alarm options have been ordered.

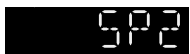

The function key will allow the user to edit the alarm 1 setpoint value. This menu option is only displayed if any of the alarm options have been ordered.



The function key will allow the user to edit the alarm 1 setpoint value. This menu option is only displayed if any of the alarm options have been ordered.



The function key will allow the user to edit the alarm 1 setpoint value. This menu option is only displayed if any of the alarm options have been ordered.



The function key will display hold the current measured weight value. The display will flash "HOLD" to indicate that the displayed value is the display hold value. Press the function key again to cancel the display hold function.

### 4.11 Digital Input Configuration Menu



This menu configures the two digital inputs. The digital inputs can be configured for specific functions as listed below.



The digital input is disabled.



The digital input will toggle the display in the following order. The minimum recorded weight, the maximum recorded weight and then the current measured weight value. The display will flash either "MIN" or "MAX" to indicate that the displayed value is either the minimum or maximum recorded weight.



The digital input will reset the minimum and maximum recorded values to the current measured weight value.



The digital input will reset any of the latched alarms when the alarm condition has been removed. This menu option is only displayed if any of the alarm options have been ordered and the alarm latch function has been activated.



The digital input will toggle the display between showing the gross and net weight. The net status indicator will illuminate to indicate that the display is showing the net weight.

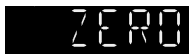

This function will perform a manual zero within the zero band setting. This is a useful function if there is some residue material left on the scale.



The digital input will tare the gross weight and it will then automatically swap the display to show the net value. The net status indicator will illuminate to indicate that the display is showing the net weight.



The digital input will display hold the current measured weight value. The display will flash "HOLD" to indicate that the displayed value is the display hold value. Activate the digital input again to cancel the display hold function.

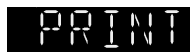

This menu option is only shown if either the RS232 or RS485 ASCII Out mode is selected. This digital input allows the user to print the display value either via the RS232 or the RS485 interface. The display will briefly flash "PRINT" when the digital input is activated.

### 4.12 Miscellaneous Configuration Menu



This menu configures the miscellaneous functions of the instrument.



Select this option if you want to password protect the menu system. Select "NONE" for no menu protection, "FULL" for all menu options to be password protected, or "ALM.VAL" for all menu options except the alarm setpoints to be password protected.

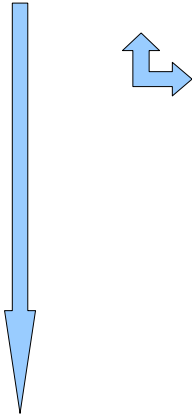

Use the front panel push buttons to enter a unique password.

If a password has been set and one of the levels for access control has been selected then the instrument will prompt the user to enter the password. If the code is correct then it will allow the user into the menu system otherwise it will return to the normal display mode.



This menu option allows the user to set the RTC (Real Time Clock). This menu option is only displayed if the RTC option has been ordered

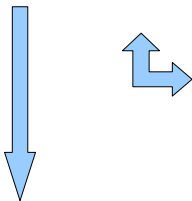

Use the front panel push buttons to set the date.



Use the front panel push buttons to set the time.



Select this menu option to display the instruments serial number.



This menu option will do a display test by turning all the segments on. Press enter or the menu key to return to the miscellaneous menu option.

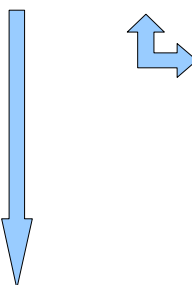





This menu option allows access to technical functions such as input signal and analog output calibration. These functions are accessed by the factory during the calibration of the instrument. Please consult the factory for more information.

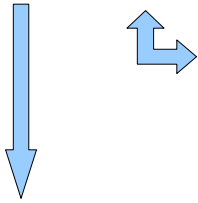

Use the front panel push buttons to enter the access code.

Back to the start of the miscellaneous configuration menu.

## 5 Error Messages

### Hardware Under Range:



If the input to the ADC (analog to digital converter) exceeds its negative limit then the hardware under range message is shown.

### Hardware Over Range:



If the input to the ADC (analog to digital converter) exceeds its positive limit then the hardware over range message is shown.

### Display Under Range:



If the display value exceeds the negative display threshold of -199999 then the display under range message is shown.

### Display Over Range:



If the display value exceeds the positive display threshold of 999999 then the display over range message is shown.

### Analog Out mA Open Loop Error:



The display will flash the error message every 5 seconds to indicate that a mA loop error has occurred. This message will only be shown if the analog out option has been ordered and the analog out has been set for any of the mA ranges.

**Other Error Messages:**



Unit settings CRC error. Load default settings to restore to factory defaults. If the error message still persists then it could possibly be a non-volatile memory failure in which case the instrument will then have to be returned to the factory.



Calibration constants CRC error. The instrument could possibly have a non-volatile memory failure in which case the instrument will then have to be returned to the factory.



Option board CRC error. The instrument has found an error with the top option PCB. It could possibly be a non-volatile memory failure in which case the instrument will then have to be returned to the factory.



Analog out calibration CRC error. Please recalibrate the analog out option. If the error message still persists then it could possibly be a non-volatile memory failure in which case the instrument will then have to be returned to the factory.



Menu list display error. Please contact the factory with diagnostic information.

## 6 Display Test, Firmware and Model Number

On start up, the instrument will do a display test whereby all the segments of the display are turned on. It will then briefly display the model number of the indicator and then the firmware revision number.



## 7 Firmware Upgrading

The LT1240 Load Cell indicator can be upgraded in the field by connecting the RS232 port to a PC and running the firmware update program. **Note that only the RS232 port can be used to upgrade the firmware.**

### Steps to follow to upgrade the firmware:

- 1) Connect the RS232 port on the instrument to the PC RS232 port as described in the table below
- 2) Run the upgrade program on the PC that matches your instrument
- 3) Select the correct Com Port and click the “Connect” button
- 4) Power up the instrument while pressing all 4 front panel push buttons.
- 5) The words “Ready to program” will be displayed in the text area and the “Update Firmware” button will be enabled
- 6) Click the “Update firmware” button and the firmware will begin to be updated
- 7) The following screen will be displayed if successful

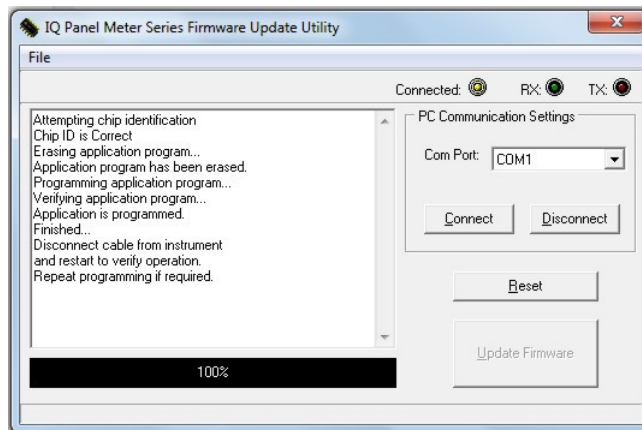

### PC connections:

D9 Female Connector	LT1240
Pin 2	Pin 9 (RS232 TXD)
Pin 3	Pin 10 (RS232 RXD)
Pin 5	Pin 11 (GND)

## 8 Loading Default Settings



Default settings can be loaded by pressing the left and up keys simultaneously at power up. The word “D.FAULT” will briefly appear on the display. All settings will be set back to the factory defaults.

## 9 Cleaning

The unit should not be cleaned with any abrasive substances. The screen is very sensitive to certain cleaning materials and should only be cleaned using a clean, damp cloth.

## 10 Ordering Information

Add option codes to suffix of model number separated by hyphens.

Example:

(LT1240 Weighing indicator with 2 mechanical relays, analog output and an additional RS485 interface)

### LT1240-711-730-740

#### Option part numbers:

- 700 - Low voltage 10-30VDC isolated power supply
- 701 - High voltage 25-70VDC isolated power supply
- 710 - 1 Mechanical relay
- 711 - 2 Mechanical relays
- 712 - 3 Mechanical relays
- 713 - 4 Mechanical relays
- 720 - 1 Solid-state relay
- 721 - 2 Solid-state relays
- 722 - 3 Solid-state relays
- 723 - 4 Solid-state relays
- 730 - 16 Bit Analog Output (0/4-20mA, 0-10V)
- 731 - 16 Bit Isolated Analog Output (0/4-20mA, 0-10V)
- 740 - Second communication RS485 interface
- 750 - RTC (Real Time Clock)
- 760 - Panel mount engineering units
- 761 - Power connector protective cover
- 762 - 115VAC Inductive load suppressor
- 763 - 230VAC Inductive load suppressor
- 764 - 2A Slow blow replacement fuse
- 765 - R-C Snubber noise and arc suppressor
- 766 - Transparent protective front cover



## 11 Website

An electronic copy of this manual can be downloaded from [www.loadtech.co.za](http://www.loadtech.co.za).

## 12 Notice

Specifications of the products displayed herein are subject to change without notice. Infiniteq cc, or anyone on its behalf, assumes no responsibility or liability for any errors or inaccuracies.

Information contained herein is intended to provide a product description only. No license, express or implied, by estoppel or otherwise, to any intellectual property rights is granted by this document. Except as provided in Infiniteq's terms and conditions of sale for such products, Infiniteq assumes no liability whatsoever, and disclaims any express or implied warranty, relating to sale and/or use of Infiniteq products including liability or warranties relating to fitness for a particular purpose, merchantability, or infringement of any patent, copyright, or other intellectual property right.

The products shown herein are not designed for use in medical, life-saving, or life-sustaining applications. Customers using or selling these products for use in such applications do so at their own risk and agree to fully indemnify Infiniteq for any damages resulting from such improper use or sale.

## 13 Warranty

This product carries a warranty for a period of one year from date of purchase against faulty workmanship or defective materials, provided there is no evidence that the unit has been mishandled or misused. Warranty is limited to the replacement of faulty components and includes the cost of labor. Shipping costs are for the account of the purchaser.

**Note:** Product warranty excludes damages caused by unprotected, unsuitable or incorrectly wired electrical supplies and or sensors, and damage caused by inductive loads.

**DISTRIBUTED BY:**