



## Short Description



- Stainless steel IP67 shear beam load cell (250kg is bending beam load cells)
- Suitable for floor scales, automobile test facilities, hopper scales and other weighing devices
- Current calibrated (sc-option)



Test certificate no. TC8010 Revision 0 and D09-05.19

C of C no R60/2000-NL1-11.28 and R60/2000-CN1-06.05



Certificate no. 12-022

## Available Models

Capacity	Accuracy	Full Article Description
250kg	C3/C4/C5	B8D-C3/C4/C5-250kg-6B
500kg	C3/C4/C5	B8D-C3/C4/C5-500kg-6B
1t	C3	B8D-C3-1t-6B
2t	C3	B8D-C3-2t-6B
5t	C3	B8D-C3-5t-6B

## Technical Specifications B8D

Accuracy Class		OIML R60 C3			OIML R60 C4	OIML R60 C5
Output Sensitivity (= FS)	mV/V	3.0 ± 0.008				
Maximum Capacity ( E <sub>max</sub> )	t	0.25	0.5, 1, 2	5	0.25, 0.5	
Max. Number of Load Cell Intervals	n <sub>LC</sub>	3000			4000	5000
Ratio of min. LC Verification Interval	Y = E <sub>max</sub> / V <sub>min</sub>	10000	7500	9000	10000	18000
Combined Error	%FS	≤± 0.023			≤± 0.018	≤± 0.014
Creep Error (30 minutes)	%FS	≤± 0.016			≤± 0.012	≤± 0.012
Temperature Effect on Zero (ZTC)	%FS/10°C	≤± 0.015			≤± 0.010	≤± 0.014
Temperature Effect on Sensitivity (STC)	%FS/10°C	≤± 0.011			≤± 0.009	≤± 0.007
Zero Balance	%FS	≤± 1.0				
Safe Overload	%FS	150				
Ultimate Overload	%FS	300				
Maximum Deflection	mm	~0.2 – 0.3				
Excitation, Recommended Voltage	V	5 ~ 12				
Excitation, Maximum Voltage	V	18				
Input Resistance	Ω	350 ± 3.5				
Output Resistance	Ω	350 ± 3.5				
Insulation Resistance (50V)	MΩ	≥5000				
Compensated Temperature	°C	-10 ~ + 40				
Operating Temperature	°C	-35 ~ + 70				
Load Cell Weight	kg	0.25t – 2t: 0.9 ~ 1.1			5t: 1.6	
Element Material		Stainless Steel				
Ingress Protection (acc. to EN 60529)		IP67				
Recommended Torque on Fixation Bolts	Nm	M12: 75			M20:450	
ATEX Classification (optional)		II 1G Ex ia IIC T4 Ga		II 1D Ex ia IIIC T <sub>200</sub> 135°C Da		II 3G Ex ic IIC T4 Gc

## Wiring

### Features:

Cable type: Shielded, 4 conductor cable , conductor AWG 22  
 Cable diameter: Ø 5.0mm  
 Cable length: 6m  
 Cable jacket: Polyurethane  
 Shield not connected to element

### 4-Wire Connection Diagram

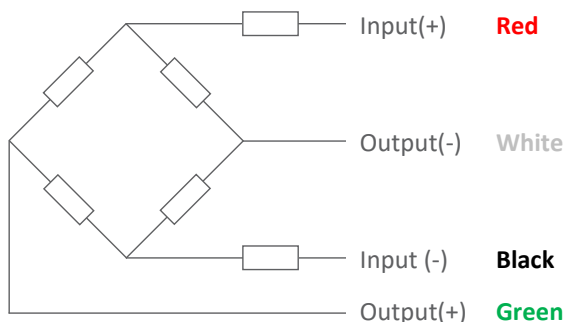

Specifications and dimensions are subject to change without notice and do not constitute any liability whatsoever.

## Dimensions in mm

250kg Top View

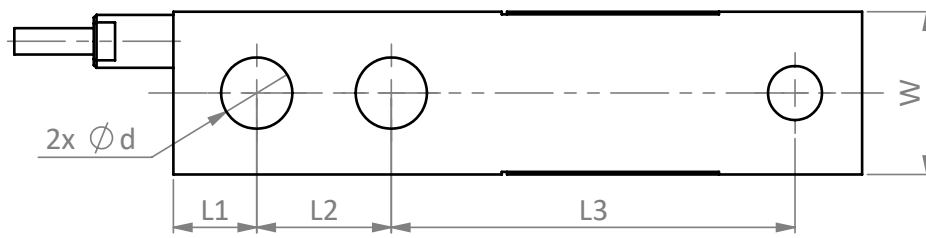

250kg Side View

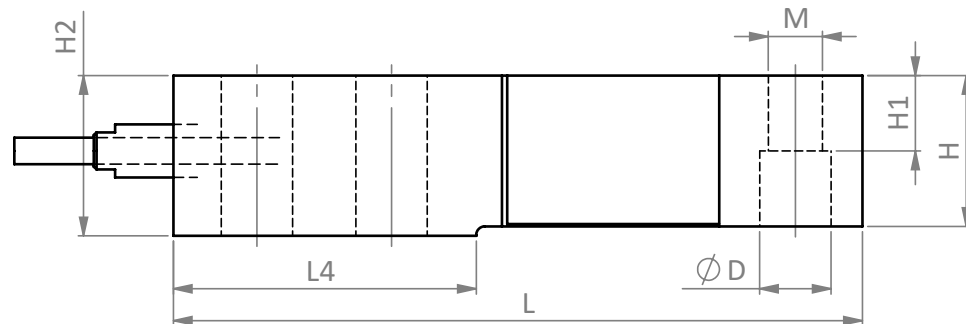

500kg – 5t Top View

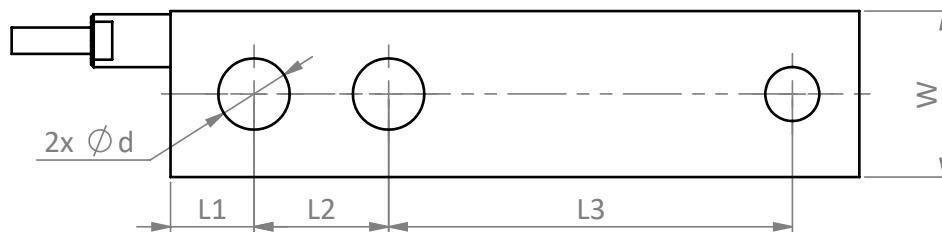

500kg – 5t Side View

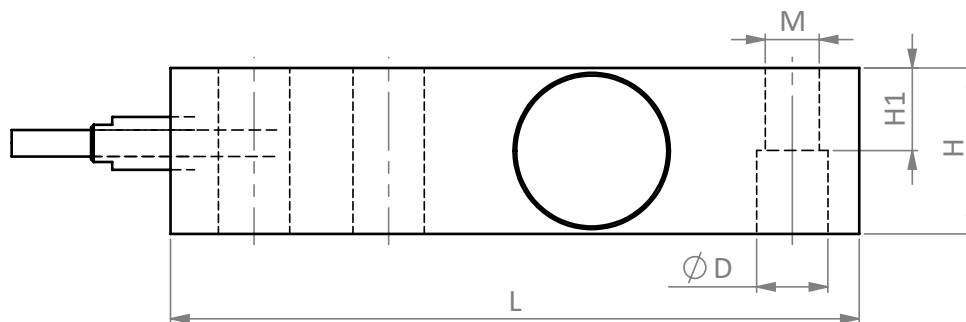

Dimension Capacity	L	L1	L2	L3	d	H	W	D	H1	H2	L4	M
0.25t	130.0	15.7	25.4	76.2	13.46	28.45	30.73	13.46	14.23	30.23	57.15	M12
0.5t-2t	130.0	15.7	25.4	76.2	13.46	31.32	31.32	13.46	15.75	-	-	M12
5t	171.5	19.1	38.1	95.2	20.65	36.83	36.83	20.65	18.85	-	-	M20

Specifications and dimensions are subject to change without notice and do not constitute any liability whatsoever.

## Available Accessories

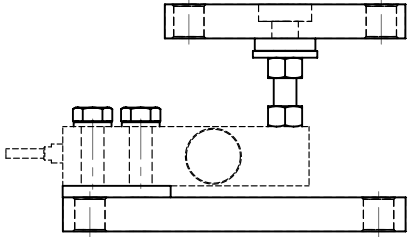
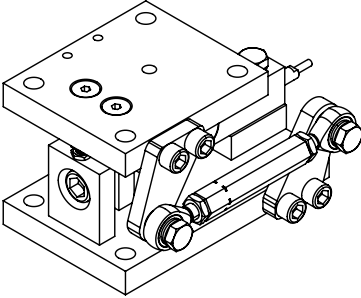
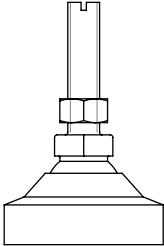
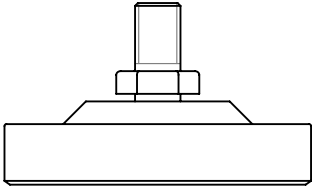
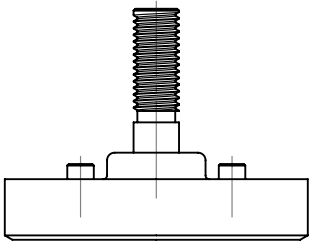
<p><b>BM-8-404-0.5-5t Mount</b></p> <ul style="list-style-type: none"> <li>• Hardened stainless steel components</li> <li>• Compact construction</li> <li>• Using under heavy static load or slight dynamic load</li> <li>• Good ability against corrosive environments</li> </ul>	
<p><b>BM-8-902-0.25-5t Mount</b></p> <ul style="list-style-type: none"> <li>• Complete mounting set with lift-off protection</li> <li>• Stainless steel</li> <li>• Using under heavy static load or slight dynamic load</li> <li>• Optional stay-rod assembly</li> <li>• Good ability against corrosive environments</li> </ul>	
<p><b>BJ-8-202-0.5-5t Foot</b></p> <ul style="list-style-type: none"> <li>• Ø60-80 and height 92-105 mm</li> <li>• Stainless Steel</li> <li>• Adjustable height</li> <li>• Self-centering</li> </ul>	
<p><b>BJ-8-215-0.5-2t Foot</b></p> <ul style="list-style-type: none"> <li>• Ø81 and height 48 mm</li> <li>• Easy installation</li> <li>• Adjustable height</li> <li>• Automatically centralized inside</li> <li>• Good ability of anti-side loading</li> <li>• Mainly used for platform scales, floor scales and other electronic weighing devices</li> </ul>	
<p><b>BJ-8-219-0.5-2t &amp; BJ-8-220-0.5-2t Feet</b></p> <ul style="list-style-type: none"> <li>• Ø80 and height 61mm (-219) / 56,5mm (-220)</li> <li>• Stainless steel</li> <li>• Easy installation</li> <li>• Automatically centralized inside</li> <li>• Good ability of anti-side loading</li> <li>• Mainly used for platform scales, floor scales and other electronic weighing devices</li> </ul>	
<p><b>HD-8-301-0.1-10t Spacer Plate</b></p> <ul style="list-style-type: none"> <li>• Nickel Plated alloy steel</li> <li>• 3 different sizes for 3 capacity ranges</li> <li>• Easy installation</li> </ul>	